



# ASSEMBLY INSTRUCTIONS

## TECHART Aero-Kit for 992 Carrera

Consisting of:

Part-no. 092.100.100.009	Front spoiler
Part-no. 092.100.350.009	Side skirts Carrera
Part-no. 092.100.500.009	Diffusor add-on for rear apron
Part-no. 092.100.501.009	Diffusor add-on for SportDesign rear apron
Part-no. 092.100.800.009	Rear spoiler I
Part-no. 092.100.810.009	Rear spoiler II Coupe
Part-no. 092.100.811.009	Rear spoiler II Cabriolet

Version 08-05/2021





# ASSEMBLY INSTRUCTIONS













## TECHART Aero-Kit for 992 Carrera









### Contents

<b>I</b>	<b>Important safety information .....</b>	<b>..3</b>
<b>II</b>	<b>Preparation .....</b>	<b>..4</b>
<b>III</b>	<b>Installation .....</b>	<b>10</b>
1	Prepare vehicle .....	10
1.1	Paint preparation .....	10
1.2	Remove wheels and detachable parts .....	12
2	TECHART AeroKit for 992 Carrera .....	13
2.1	Preliminary work front spoiler .....	13
2.2	Install TECHART front spoiler .....	14
2.3	Preliminary work side skirt .....	17
2.4	Install TECHART side skirts .....	18
2.5	Install rear diffuser .....	19
2.6	Install TECHART rear spoiler I .....	22
2.7	Install TECHART rear spoiler II .....	23
3	Final check .....	39
4	Self-help .....	39

### I Important safety information

All of the necessary work must be performed by qualified persons with an appropriate level of expertise.

	<p style="text-align: center;"><b>⚠ WARNING</b></p> <p>Vehicle lifts with an insufficient lifting capacity can collapse under the weight of the vehicle and crush any persons standing underneath.</p> <p>Compare the weight of the vehicle with the lifting capacity of your vehicle lift. The weight of the vehicle must not exceed the lifting capacity of your vehicle lift. The weight of the vehicle can be found in the vehicle operating manual.</p>	
	<p style="text-align: center;"><b>⚠ WARNING</b></p> <p>Risk of injury from electric current.</p> <p>Switch off the ignition and disconnect the battery when working on the vehicle electrical/electronic systems.</p>	
   	<p style="text-align: center;"><b>⚠ WARNING</b></p> <p>Risk of fire and explosion from ignition of windshield cleaning agents/antifreeze and their vapors.</p> <p>Risk of poisoning from ingesting windshield cleaning agents/antifreeze and breathing in their vapors.</p> <p>Risk of injury due to irritation caused by windshield cleaning agents/antifreeze coming into contact with eyes, skin and other parts of the body.</p> <p>Wear protective clothing and safety glasses. Avoid naked flames, fire and sources of ignition. Avoid contact with eyes, skin and other parts of the body. Do not eat, drink or smoke when handling windshield cleaning agents/antifreeze. Do not breathe in vapors and ensure adequate ventilation. Keep windshield cleaning agents/antifreeze only store them in sealable original containers.</p>	  
  		

 	<p style="text-align: center;"><b>CAUTION</b></p> <p>Risk of injury from hands and arms being crushed, cut or lacerated when working with sharp-edged and bulky objects.</p> <p>Wear protective clothing and protective gloves. Keep limbs out of narrow and inaccessible areas of the vehicle and/or avoid dangerous situations by using special tools and suitable aids.</p>	 
	<p style="text-align: center;"><b>CAUTION</b></p> <p>Risk of injury to back, muscles, joints, tendons and ligaments from lifting and carrying heavy and/or bulky objects.</p> <p>Lift and transport heavy and/or bulky objects with the help of other people and/or with suitable aids.</p>	
	<p style="text-align: center;"><b>NOTICE</b></p> <p>Before starting the assembly procedure, carefully read the assembly instructions in full and pay attention to the safety information and sequence of the individual operation steps.</p>	
	<p style="text-align: center;"><b>NOTICE</b></p> <p>All body parts must be prepared and painted in accordance with the attached painting guide.</p>	

## II Preparation

### Number of people required

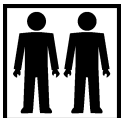

For the installation of this product at least two persons are needed.

### Help and support

If you have any technical queries, please contact us immediately:  
[support@techart.de](mailto:support@techart.de)





# ASSEMBLY INSTRUCTIONS

## TECHART Aero-Kit for 992 Carrera

### Check TECHART Aerokit I parts kit for completeness

<b>1</b>	<b>092.100.100.009</b>	<b>Front spoiler I</b>
Consisting of:		
1	092.100.100.100	Front spoiler
1	092.100.100.140	Grille panel, blank
2	092.100.100.200	Bracket, front spoiler
2	0039004816A2SW	Collar screw Torx 4.8x16, A2, black
2	0029004.8/16.7X11	Speed nut, 4.8/16.7x11.0, yellow galvanized
5	0039004.2X951025	Sheet metal screw fillister head with flange 4.2x9.5
8	000100999999	Collar screw for plastic PT 50 x 16 pointed
4	0039004.8X191025	Sheet metal screw fillister head with flange 4.8x19
1	00091089010031	Bond and Seal, 70ml tube
1	092.140.100.009	Set stone protective foil

### Parts-kit options for rear spoiler II

<b>1</b>	<b>+92.100.100.001</b>	<b>V01: Splitter and panels paintable</b>
Consisting of:		
1	092.100.100.102	Splitter
1	092.100.100.110	Panel right
1	092.100.100.111	Panel left

or

<b>1</b>	<b>+92.100.100.003</b>	<b>V01: Splitter and panels in custom color</b>
Consisting of:		
1	092.100.100.102CCC	Splitter in custom color painted
1	092.100.100.110CCC	Panel right painted in custom color
1	092.100.100.111CCC	Panel left painted in custom color



# ASSEMBLY INSTRUCTIONS

## TECHART Aero-Kit for 992 Carrera

<b>1</b>	<b>092.100.350.009</b>	<b>Side skirts</b>
Consisting of:		
1	092.100.350.100	Side skirt right
1	092.100.350.101	Side skirt left
20	0009014,8X1693614816	Rivet truss head 4.8x16 black
18	0039004816A2SW	Collar screw Torx 4.8x16, A2, black
18	0029004.8/19.0X12.7	Speed nut 19mm x 4.8mm
2	00091089010031	Bond and Seal, black, 70ml tube
1	091.140.340.009	Set stone protective foil

### Parts-kit options for side skirts

<b>1</b>	<b>+92.100.350.001</b>	<b>V01: Bottom part paintable</b>
Consisting of:		
1	092.100.350.110	Bottom part right
1	092.100.350.111	Bottom part left

or

<b>1</b>	<b>+92.100.350.003</b>	<b>V01: Bottom part in custom color</b>
Consisting of:		
1	092.100.350.110CCC	Bottom part right painted in custom color
1	092.100.350.111CCC	Bottom part left painted in custom color



# ASSEMBLY INSTRUCTIONS

## TECHART Aero-Kit for 992 Carrera

<b>1</b>	<b>092.100.500.009</b>	<b>Diffusor add-on for rear apron</b>
Consisting of:		
1	092.100.500.100	Diffusor
1	092.100.500.300	Bracket rear diffusor front right
1	092.100.500.301	Bracket rear diffusor front left
1	092.100.500.310	Bracket rear diffusor rear right
1	092.100.500.311	Bracket rear diffusor rear left
<b>1</b>	<b>092.100.501.009</b>	<b>Diffusor add-on for SportDesign rear apron</b>
Consisting of:		
1	092.100.501.100	Diffusor
1	092.100.500.300	Bracket rear diffusor front right
1	092.100.500.301	Bracket rear diffusor front left
for both:		
1	092.100.500.500	Heat protection incl. bracket
8	0039004816A2SW	Collar screw Torx 4.8x16, A2, black
4	0029004.8/16.7X11	Speed nut, 4.8/16.7x11.0, yellow galvanized
5	000.100.999.999	Collar screw for plastic PT5x16
2	001900M06X20 274	Screw self-locking M6X20 yellow galvanized
1	00091089010031	Bond and Seal black, 70 ml tube
1	092.140.500.009	Set stone protection foil

### Parts-kit options for diffusor add-on

<b>1</b>	<b>+92.100.500.001</b>	<b>V01: Bottom part paintable</b>
Consisting of:		
1	092.100.500.125ZB	Set of fins, 5 parts

or

<b>1</b>	<b>+92.100.500.003</b>	<b>V01: Bottom part in custom color</b>
Consisting of:		
1	092.100.500.125CCC	Set of fins, 5 parts, painted in custom color

<b>1</b>	<b>092.100.800.009</b>	<b>Rear spoiler I</b>
Consisting of:		
1	092.100.800.100	Rear spoiler
or		
1	092.121.800.100	Rear spoiler "Carbon" glossy or matt
1	00091089010031	Bond and Seal black, 70 ml tube



# ASSEMBLY INSTRUCTIONS

## TECHART Aero-Kit for 992 Carrera

<b>1</b>	<b>092.100.810.009</b>	<b>Rear spoiler II</b>
Consisting of:		

Coupe:		
1	092.100.810.100	Base frame
1	092.100.810.220	Base, Coupe
1	092.120.810.204	Mounting plate right Makrolon
1	092.120.810.205	Mounting plate left Makrolon
1	092.120.810.224	Insert R for Makrolon Mounting plate
1	092.120.810.225	Insert L for Makrolon Mounting plate

or Cabriolet:		
1	092.100.811.100	Base frame
1	092.100.811.220	Base, Cabriolet
1	092.120.811.204	Mounting plate right Makrolon
1	092.120.811.205	Mounting plate left Makrolon
1	092.120.811.224	Insert R for Makrolon Mounting plate
1	092.120.811.225	Insert L for Makrolon Mounting plate
1	00059077007549	Cable 0.75 mm <sup>2</sup> black-red
1	0005905555160	Butt connector watertight transparent 0.2- 0.5 qm <sup>2</sup>

Coupe and Cabriolet:		
1	092.100.810.101	Frame, blank
1	092.100.810.110	Panel air intake right
1	092.100.810.111	Panel air intake left
1	092.100.810.130	Inner part top right
1	092.100.810.131	Inner part top left
1	092.100.810.132	Inner part bottom
1	092.100.810.500	Cover center mounted stop lamp
1	092.100.810.600	Grille
1	092.180.810.009	Center mounted stop lamp
1	092.100.810.300	Bracket base frame right
1	092.100.810.301	Bracket base frame left
1	092.100.810.302	Bracket base frame center
1	092.100.810.310	Bracket buffer stop base frame right
1	092.100.810.311	Bracket buffer stop base frame left
2	092.100.810.310	Bracket Z buffer stop base frame right
1	092.100.810.311	Bracket Z buffer stop base frame left
1	092.540.810.200	Rear spoiler control





# ASSEMBLY INSTRUCTIONS

## TECHART Aero-Kit for 992 Carrera

<b>1</b>	<b>092.100.810.990ZB</b>	<b>Set mounting material</b>
Consisting of:		
7	0019002005M08	Speed nut, M8, Type 6 galvanized
4	001900M8X167380-2SW	Fillister head screw with flange M 8x16/A2 black
6	001900M8X407380-2SW	Fillister head screw with flange M 8x40/A2 black
1	001900M8X607380-2SW	Fillister head screw with flange M 8x60/A2 black
4	00092110108455	Rubber-metal-stopper version D, M6x25/13.5
2	0009211047430	Rubber-metal-stopper version D, M6x20/23
2	001900M06X16912	Socket screw M6x16
2	001900M06X15	Washer DIN 522, 6.4x15x1,5 mm, galvanized
8	001900M06W379006	Nut with wave washer, M6, galvanized A2K
4	0089003696	Hexagon nut self-locking M6
4	001900M08X25912	Hexagon socket head screw M8x25
4	00091003688	Hexagon nut self-locking M8
4	001900M08X25	Washer, M 8x25, galvanized
2	001900M08X20	Washer, M 8x20, galvanized
4	001900M6X187380-2SW	Hexagon socket head screw, M 6x18, flange, black galvanized
8	0001000026515905	Washer black PA6.6
4	001900M0615877/HS	Cap nut M 6, black galvanized for rear spoiler II
2	50001900M5X16A27380	Fillister head screw with flange M 5x16 A2
2	000900094870	Hexagon socket head screw, M 8x70
2	00090103,0/1,0SW	Heat-shrinking tube, black 3.0/1.0 with inside adhesive
2	000590502221	Cable tie metal tongue 3.5x140mm in black
25	000.100.999.999	Collar screw for plastic PT 50 x 16 pointed
25	001900M056798	Serrated washer 5.0 externally toothed -DIN 6798 M5
4	000100130006022003	Protection cap M6, height 3.2mm, SW10.0mm, black

### Parts-kit options for rear spoiler II

<b>1</b>	<b>+92.100.810.101</b>	<b>V02: Profile paintable</b>
Consisting of:		
1	092.100.810.200	Profile right
1	092.100.810.201	Profile left

<b>1</b>	<b>+92.100.810.301</b>	<b>V02: Rear spoiler panel paintable</b>
Consisting of:		
1	091.100.810.210	Rear spoiler panel right
1	092.100.810.211	Rear spoiler panel left

Please use the table to check whether all of the required parts are present.

Once parts have been removed from their original packaging, ensure that they are properly handled and stored.



# ASSEMBLY INSTRUCTIONS

## TECHART Aero-Kit for 992 Carrera

### III Installation

#### 1 Prepare vehicle

- i** Before starting work, check that the vehicle is free from defects. Use the PIWIS system tester to read out all the fault memories of the individual vehicle components and first rectify any faults displayed.

#### 1.1 Paint preparation

- i**
- 092.100.100.102 TECHART splitter
  - 092.100.100.140 TECHART grille panel (optionally in car color)
  - 092.100.120.110 TECHART panel right
  - 092.100.120.111 TECHART panel left
  - 092.100.350.110 TECHART bottom part right
  - 092.100.350.111 TECHART bottom part left
  - 092.100.500.125ZB TECHART fin set, 5 parts
  - 092.100.810.110 TECHART panel air intake right
  - 092.100.810.111 TECHART panel air intake left
  - 092.100.810.200 TECHART profile right (optionally in car color)
  - 092.100.810.201 TECHART profile left (optionally in car color)
  - 092.100.810.211 TECHART base (optionally in car color)
  - 092.100.810.220 rear spoiler panel right (optionally in car color)
  - 092.100.810.221 rear spoiler panel left (optionally in car color)
- will receive a contrasting color.

- i**
- The following parts must not be painted:
- 092.100.100.100 TECHART front spoiler / part area R&L fig. L1
  - 092.100.810.130 TECHART inner part top right
  - 092.100.810.131 TECHART inner part top left
  - 092.100.810.132 TECHART inner part bottom



# ASSEMBLY INSTRUCTIONS

## TECHART Aero-Kit for 992 Carrera

### TECHART Frontspoiler

- 1 Mask the TECHART front spoiler at the shaft area and do not paint.



Fig. L1

### Only for vehicles with SportDesign front apron

- 2 Shorten the insertion of the TECHART front spoiler in the center about 3mm.



Fig. L2

### TECHART base frame

- 3 Paint the bars at the TECHART base frame right and left in black.

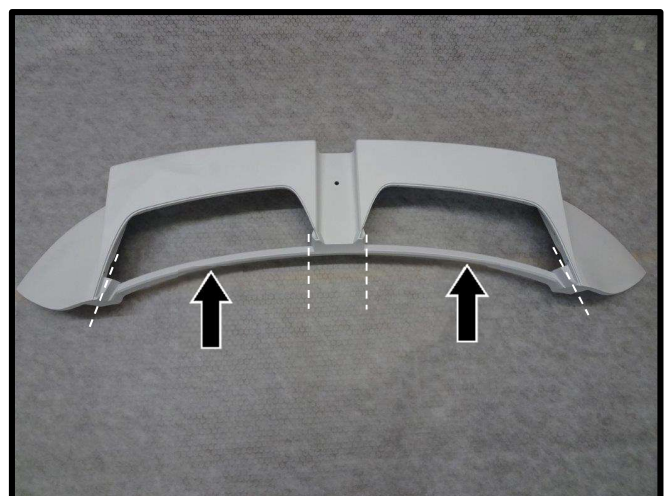

Fig. L3

### TECHART profiles

- 4 Paint the aluminum bracket in black.

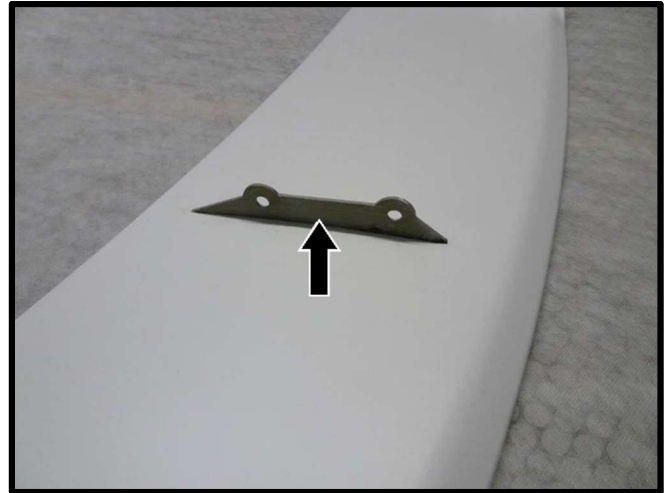

Fig. L4

### TECHART insert Makrolon for mounting plate

- 5 Only paint the inner side (uncoated, blue dot) of the TECHART insert Makrolon for mounting plate.



Fig. L5

## 1.2 Remove wheels and detachable parts

- 1 Raise vehicle at the factory-fitted jacking points.
- 2 Detach the wheels.

## 2 TECHART Aerokit for 992 Carrera

### 2.1 Preliminary work front spoiler

- 1 Unclip the original splitter and rubber lip from the original front apron (1).

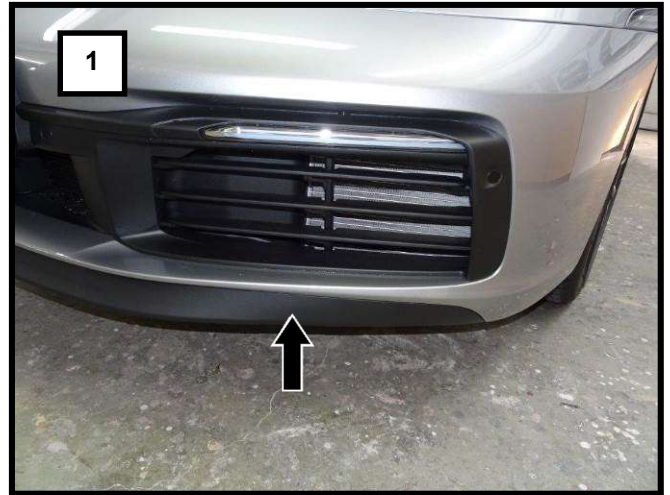

Fig. 01

 The rubber lip is no longer needed.





# ASSEMBLY INSTRUCTIONS

## TECHART Aero-Kit for 992 Carrera

### 2.2 Install TECHART front spoiler

**i** The bonding surfaces on the TECHART front spoiler and front apron must be dry and free from dust and paint spray mist!

Use cleaning agent to thoroughly degrease bonding surfaces on the TECHART front spoiler and front apron. Then sand it down using 100-180 grade abrasive paper and finally use cleaning agent to degrease it again.

Do not touch the surfaces after they have been cleaned.

**i** The insertion of the TECHART front spoiler to the front apron has to be blank and free of varnish!

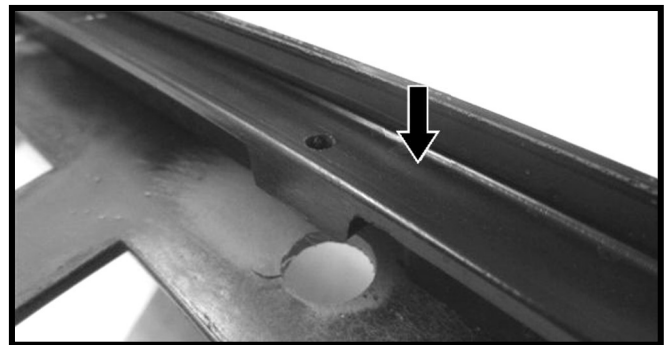

Fig. 02

- 1 Attach the TECHART grille 092.100.100.140 (2) to the TECHART front spoiler 092.100.100.100 (3).

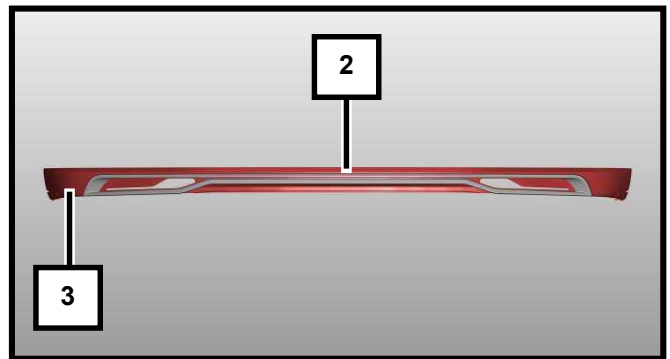

Fig. 03

- 2 Tighten the TECHART grille (2) with the screws 5x16 to the TECHART front spoiler (3) (see arrows), at (a) use the screws 4.8x19.

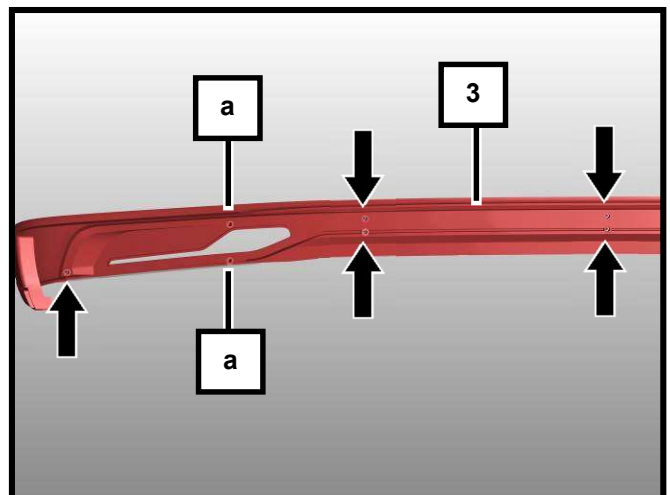

Fig. 04

- 3 Apply an even layer of PU-adhesive to the bonding surface of the TECHART panels R & L 092.100.100.11\_ (4).
- 4 Glue the TECHART panels (4) to the TECHART front spoiler (1).

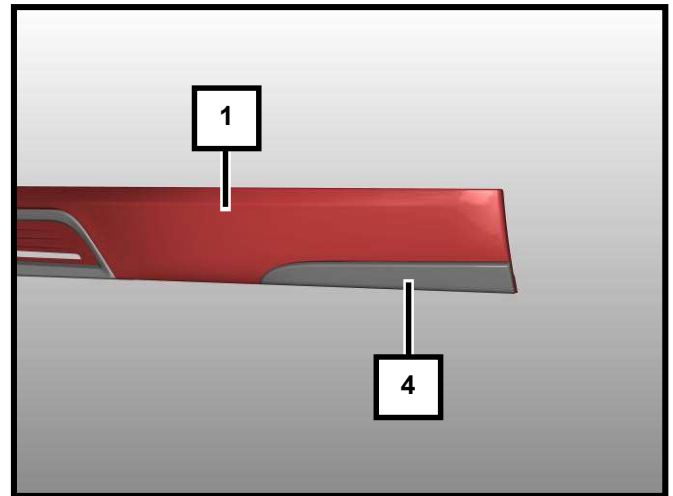

Fig. 05

**i** Press on firmly in areas coated with adhesive. Check for an accurate fit – Immediately remove any PU adhesive that escapes using a cleaning agent.

- 5 Tighten the TECHART splitter 092.100.100.103 (5) with the screws 4.2x9.5 to the TECHART front spoiler (1).

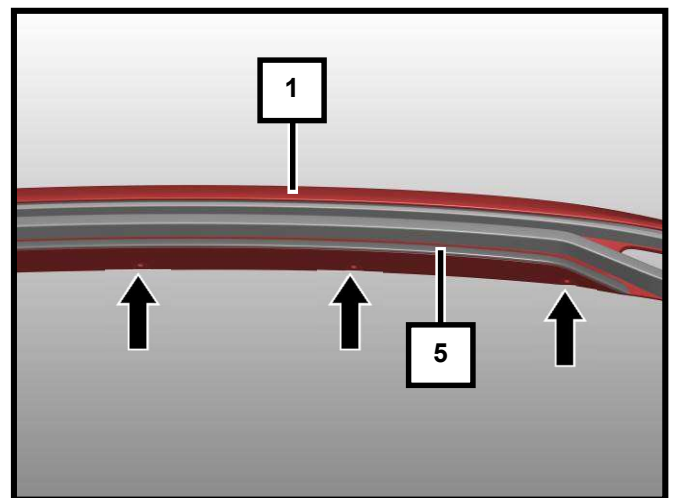

Fig. 06

- 6 Screw the TECHART bracket 092.100.100.200 (6) to the front apron (1).
- 7 Slide the speed nut 4.8 to the TECHART bracket (6).

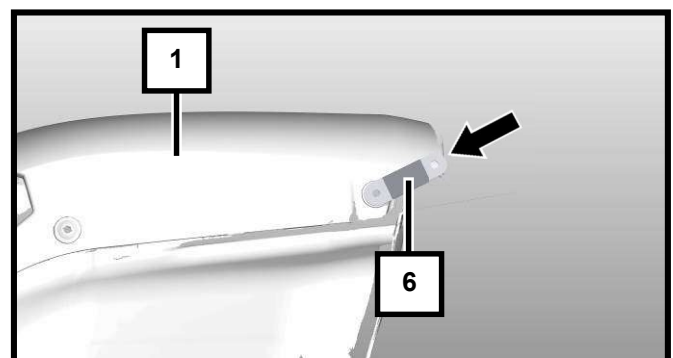

Fig. 07

- 8 Apply an even layer of PU-adhesive to the bonding surface (b) of the TECHART front spoiler (3).

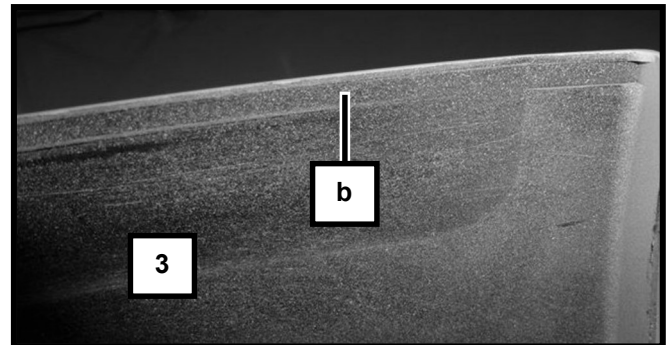

Fig. 08

- 9 Slide the TECHART front spoiler from the bottom (3) onto the front apron (1) and feed to the wheel houses.



Fig. 09

**i** Press on firmly in areas coated with adhesive. Check for an accurate fit – Immediately remove any PU adhesive that escapes using a cleaning agent.

- 10 Tighten the TECHART front spoiler (3) at the sides from the bottom with the screws 4.8x16 to the TECHART metal bracket (6).

- 11 Stick the stone protection foil in the wheel house.

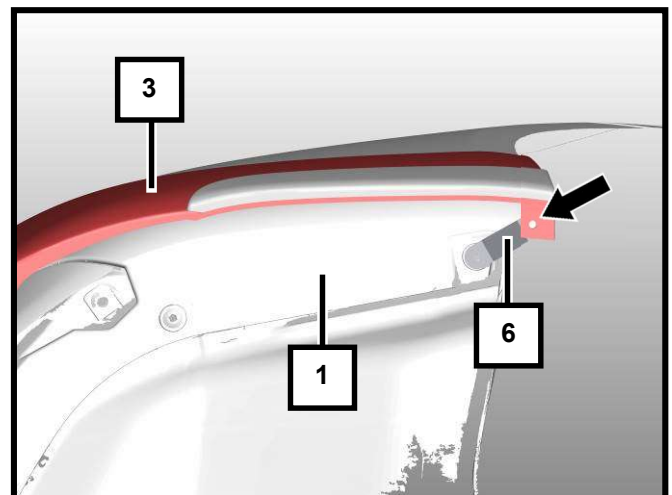

Fig. 10

**i** Allow to dry for at least 12 hours.

### 2.3 Preliminary work side skirt

- 1 Attach the speed nuts 4.8 to the TECHART side skirt bottom part 092.100.350.11\_ (7).

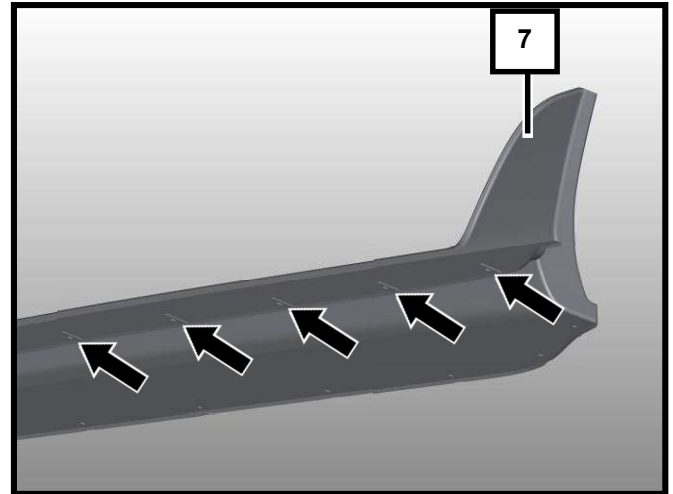

Fig. 11

- 2 Tighten the TECHART side skirt 092.100.350.10\_ (8) with the screws 4.8x16 to the TECHART side skirt bottom part (7).

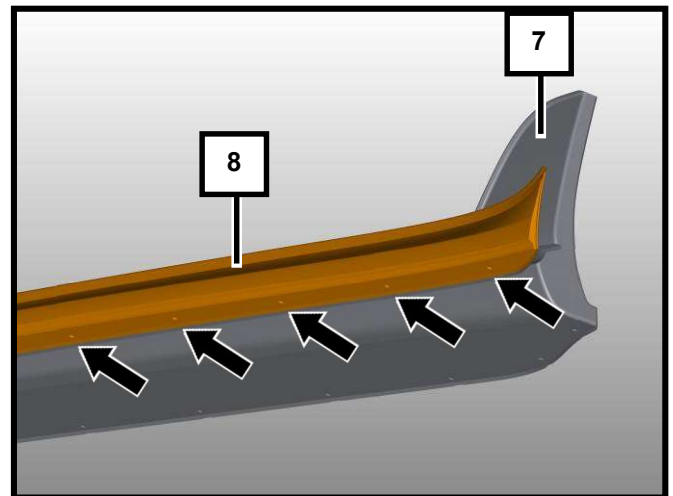

Fig. 12

### 2.4 Install TECHART side skirts

**i** The bonding surfaces on the TECHART side skirt and original side skirt must be dry and free from dust and paint spray mist.

Use cleaning agent to thoroughly degrease bonding surfaces on the TECHART side skirt and original side skirt. Then sand it down using 100-180 grade abrasive paper and finally use cleaning agent to degrease it again.

Do not touch the surfaces after they have been cleaned.

- 1 Apply an even layer of PU-adhesive to the bonding surface (c) of the TECHART side skirt and TECHART side skirt bottom part (8).

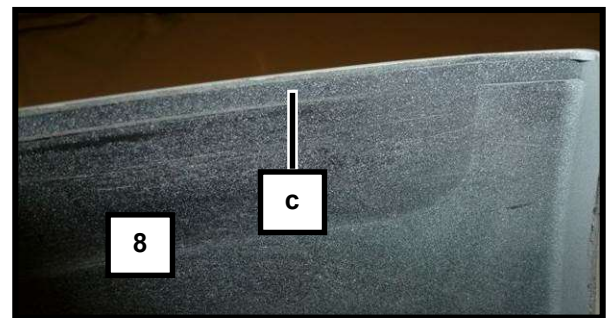

Fig. 13

- 2 Slide the TECHART side skirts (7+8) over the original side skirt and glue to the vehicle.
- 3 Stick the TECHART protection foil to the wheel arch area.

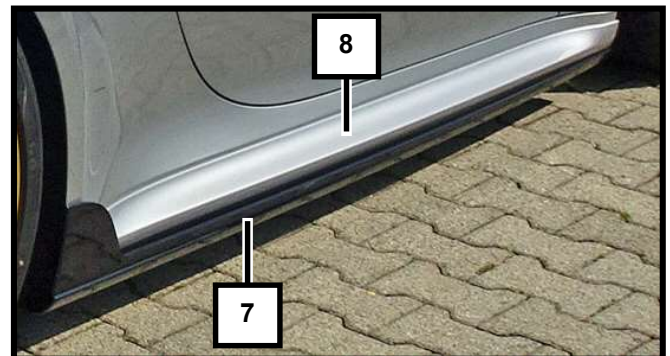

Fig. 14

**i** Press on firmly in areas coated with adhesive. Check for an accurate fit – Immediately remove any PU adhesive that escapes using a cleaning agent.

**i** Allow to dry for at least 12 hours.

- 4 Clinch the TECHART side skirt bottom part (7) with the rivet truss head 4.8x16 black to the original side skirt (9), for that drill a hole of d=5mm.

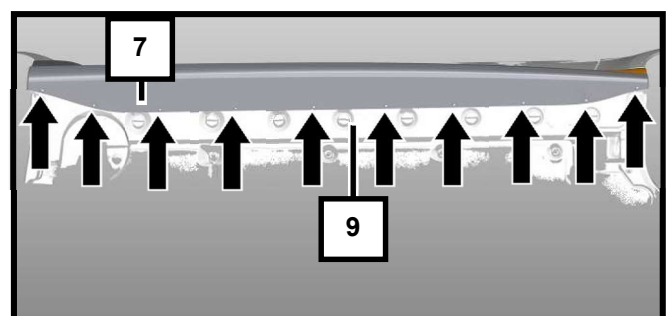

Fig. 15

- 5 Stick the stone protection foil in the wheel house.



### 2.5 Install TECHART rear diffusor

**i** The gluing surfaces on the TECHART rear diffusor and the original rear apron must be dry and free of dust or paint spraying mist!

Thoroughly degrease the gluing surfaces on the TECHART rear diffusor and the original rear apron using a cleaning agent.

Do not touch the surfaces after they have been cleaned.

- 1 Unscrew the two fixing screws for the rear apron (10) at the bottom center.
- 2 Mount the TECHART heat protection 092.100.500.500 (11) with the screws M6x20 to the rear apron (10).

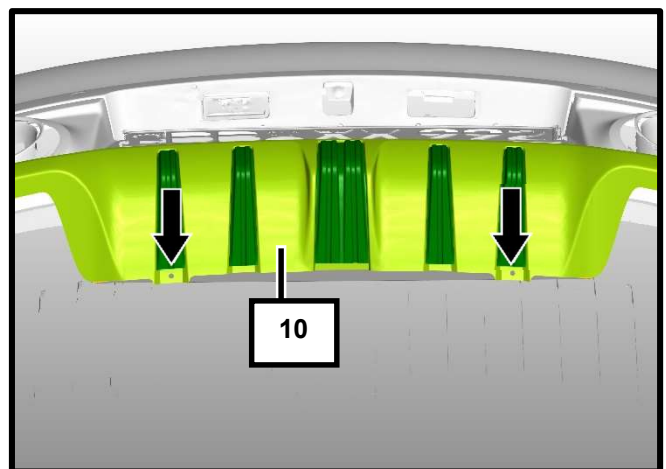

Fig. 16

#### Standard

- 3 Mount the TECHART bracket rear diffusor front right 092.100.500.300 (12) and .301 left with the screws 4.8x16 to the rear apron (10).
- 4 Mount the TECHART bracket rear diffusor rear right 092.100.500.310 (13) and .301 left with the screws 4.8x16 to the rear apron (10).

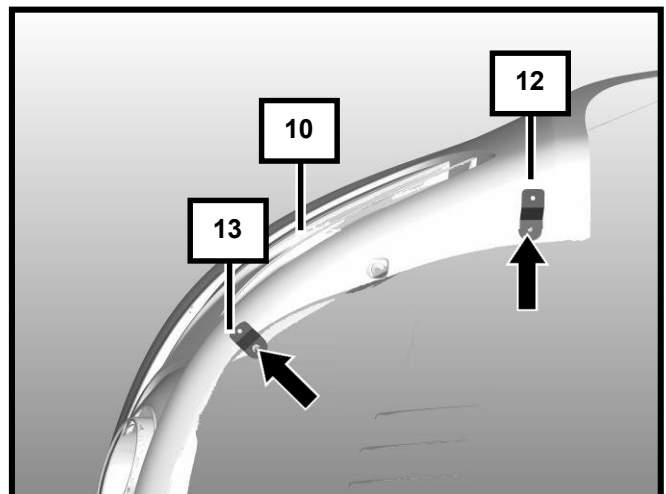

Fig. 17

**Proceed with point 6.**

#### SportDesign

- 5 Mount the TECHART bracket rear diffusor front right 092.100.501.300 (12) and .301 left with the screws 4.8x16 to the rear apron (10).
- 6 Attach the speed nut 4.8 to the TECHART bracket rear diffusor.

- 7 Apply an even layer of PU-adhesive to the bonding surface to the TECHART diffusor fins 092.100.500.124 center (A), 092.100.500.126 right outside (B), 092.100.500.127 left outside (C), 092.100.500.128 right inside (D), 092.100.500.129 left inside (E).
- 8 Glue the TECHART diffusor fins to the TECHART rear diffusor 092.100.500.100 (14) and tighten from rear side with one screw each 5x16. For that drill a hole 15mm deep with d=4mm.

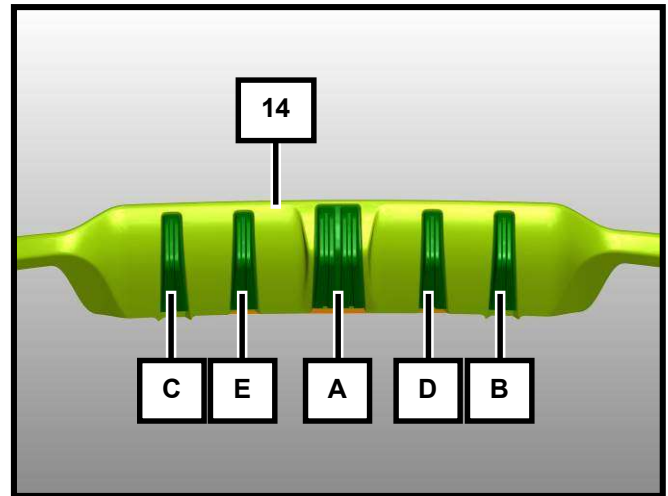

Fig. 18

- 9 Apply an even layer of PU-adhesive to the bonding surface (d) of the TECHART rear diffusor (14).

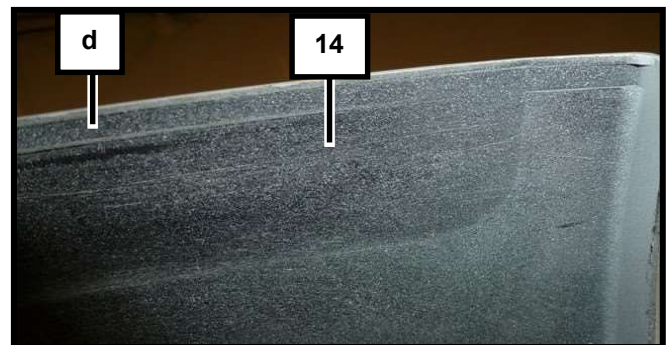

Fig. 19

- 10 Glue the TECHART rear diffusor (14) with the fins to the rear apron (10).

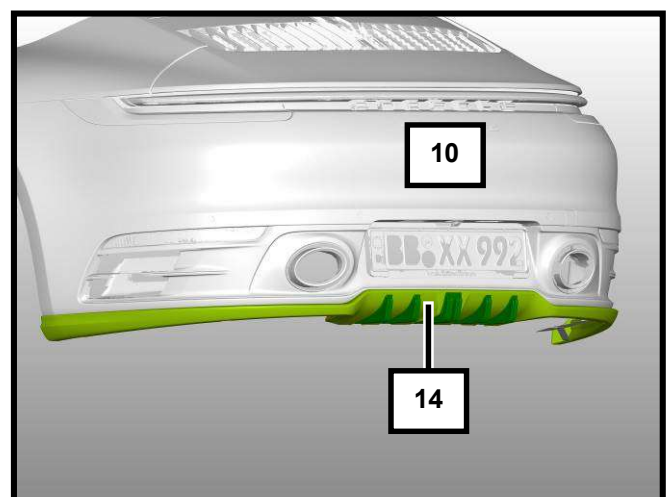

Fig. 20

**i** Press on firmly in areas coated with adhesive. Check for an accurate fit – Immediately remove any PU adhesive that escapes using a cleaning agent.

**i** Allow to dry for at least 12 hours.

- 11 Fasten the TECHART rear diffusor (14) with the screws 4.8x16 to the TECHART heat protection (11).

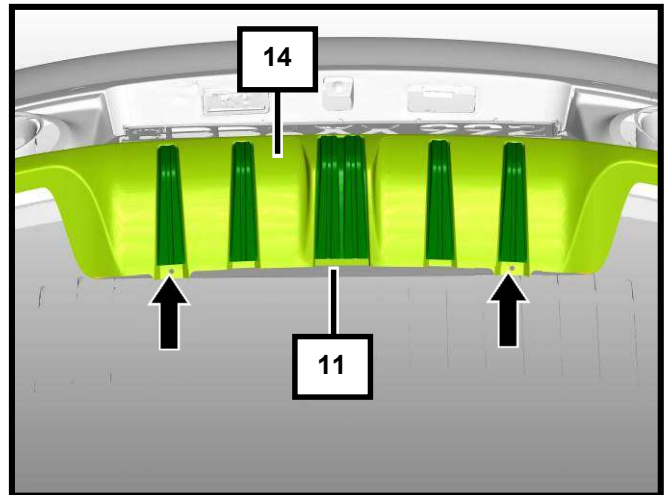

Fig. 21

### Standard:

- 12 Tighten the TECHART rear diffusor (14) with the screws 4.8x16 to the TECHART bracket rear diffusor (12+13).
- 13 Stick the stone protection foil to the wheel house.

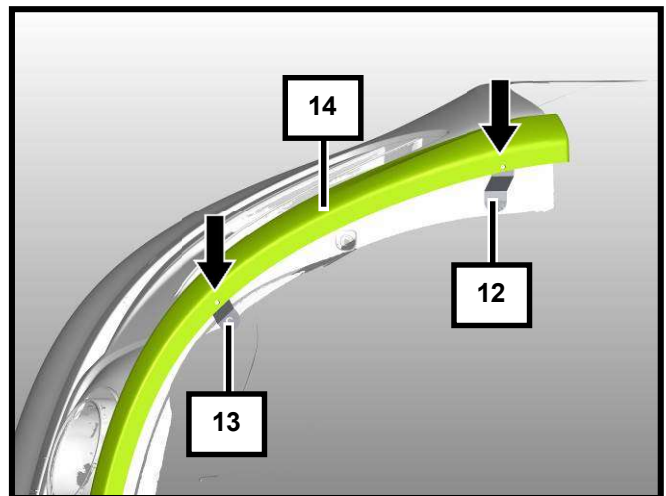

Fig. 22

### SportDesign:

- 14 Tighten the TECHART rear diffusor SportDesign (14a) with the screws 4.8x16 to the TECHART bracket rear diffusor (12+13).
- 15 Stick the stone protection foil to the wheel house.

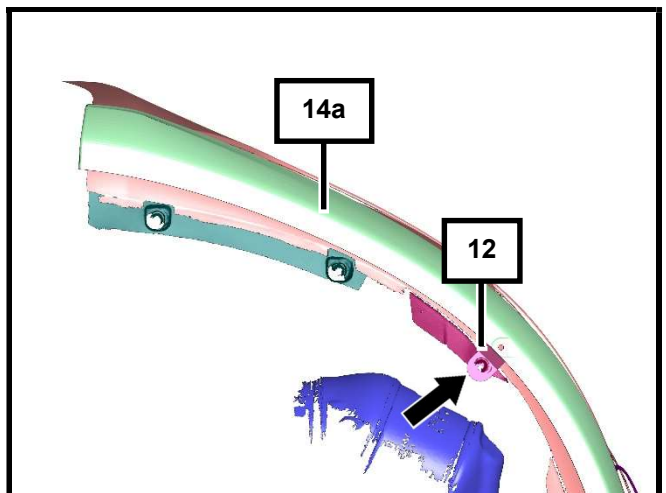

Fig. 22a

### 2.6 Install TECHART rear spoiler I

**i** The bonding surfaces on the TECHART rear spoiler and original rear spoiler must be dry and free from dust and paint spray mist.

Use cleaning agent to thoroughly degrease bonding surfaces on the TECHART rear spoiler and original rear spoiler. Then sand it down using 100-180 grade abrasive paper and finally use cleaning agent to degrease it again.

Do not touch the surfaces after they have been cleaned.

- 1 Apply an even layer of PU-adhesive to the bonding surface (d) of the TECHART rear spoiler I 092.100.800.100 (15).

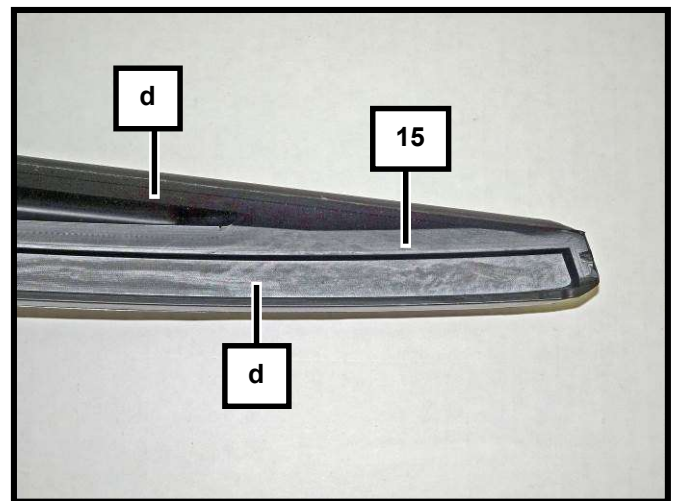

Fig. 23

- 2 Glue the TECHART rear spoiler I (15) to the original rear spoiler (16).

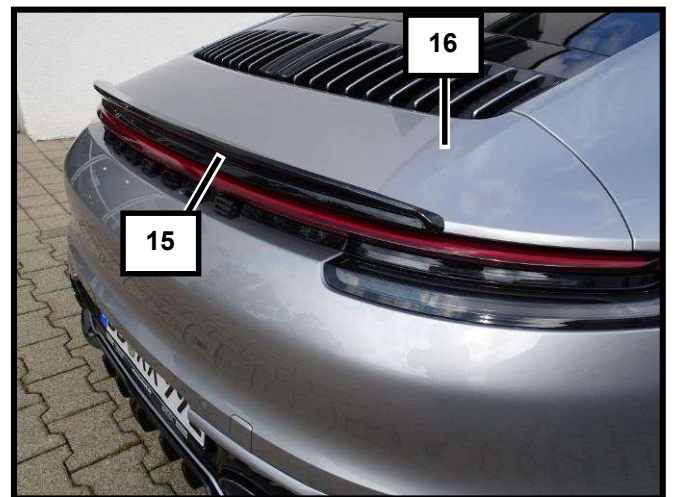

Fig. 24

**i** Press on firmly in areas coated with adhesive. Check for an accurate fit – Immediately remove any PU adhesive that escapes using a cleaning agent.

**i** Allow to dry for at least 12 hours.

### 2.7 Install TECHART rear spoiler II

**i** After crimping, heat up all crimp connectors using a hot air gun so that they form a watertight seal.

**i** The bonding surfaces must be dry and free from dust and paint spray mist. Use cleaning agent to thoroughly degrease bonding surfaces. Then sand it down using 100-180 grade abrasive paper and finally use cleaning agent to degrease it again.

Do not touch the surfaces after they have been cleaned.

- 1 Turn the ignition on.
- 2 Deploy the rear spoiler.
- 3 Turn the ignition off.



Fig. 25

- 4 Unscrew the original rear spoiler (16) from the carrier.

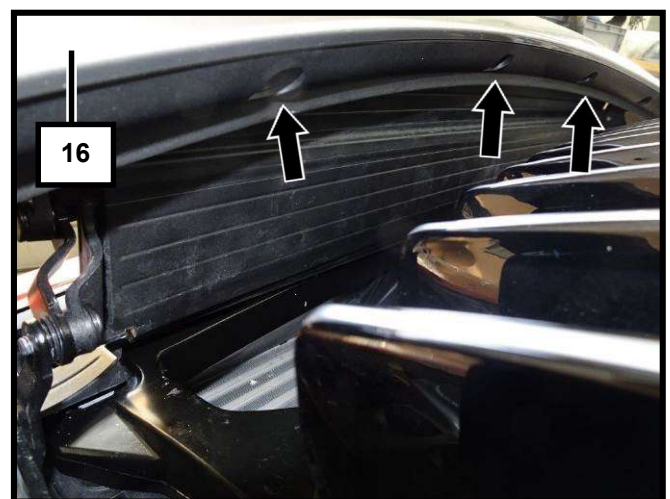

Fig. 26



- 5 Dismantle the center stop lamp from the rear spoiler bottom part (17).
- 6 Dismantle the cable of the center stop lamp.
- 7 Unscrew the original rear spoiler bottom part (12), one screw from the top and two from the bottom.

**i** The original rear spoiler and carrier are no longer required.

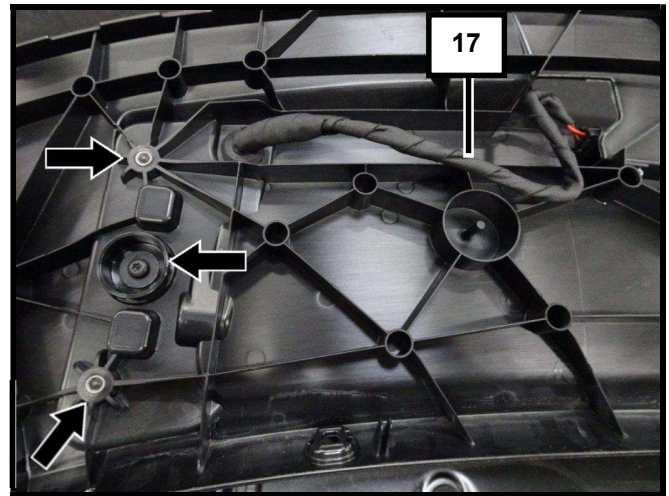

Fig. 27

- 8 Dismantle the cover right and left (18).



Fig. 28

- 9 Dismantle the mounting rubber (19) of the cover at the carrier (20).

**i** The cover and the rubber are no longer needed.

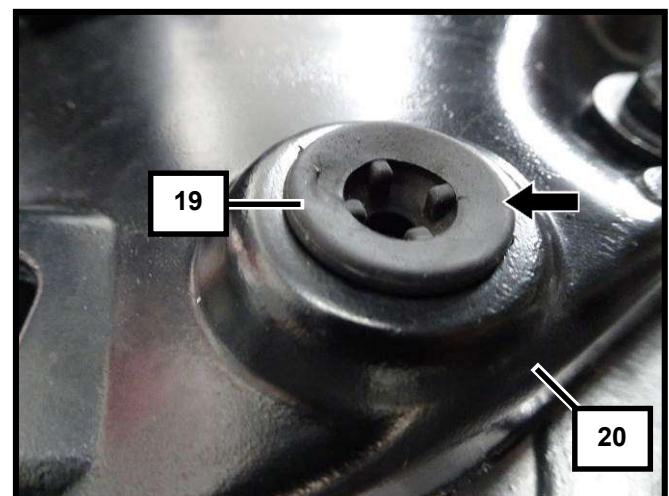

Fig. 29

- 10 Unscrew the oil and water lid.
- 11 Remove the cover over the aerator (21).
- 12 Fasten the oil and water lid again.

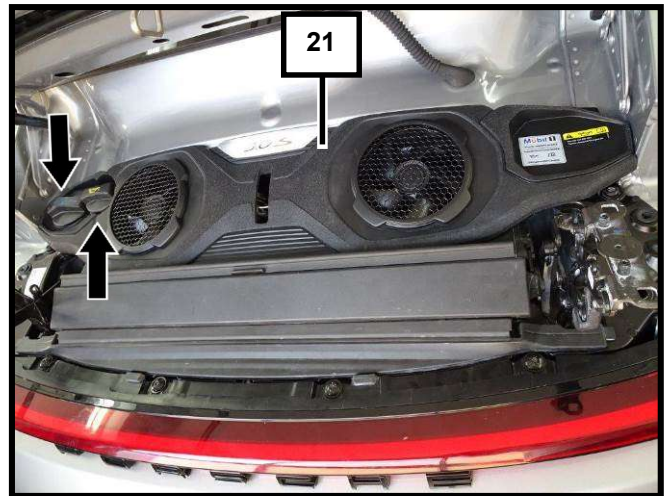

Fig. 30

- 13 Unscrew both louvers (22) of the rear spoiler unit (23) and unclip on the bottom.

**i** The louvers are no longer required.

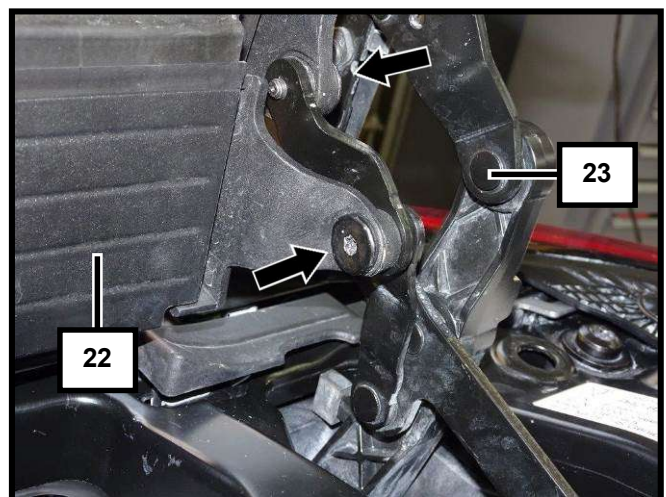

Fig. 31

- 14 Unclip both aerators (24) and separate the electrical connection.

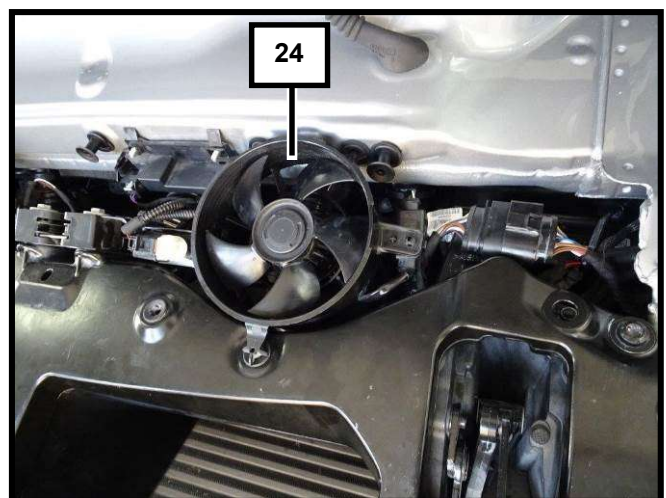

Fig. 32



- 15 Unscrew the taillight strip (25), pull it out and separate both electrical connections.

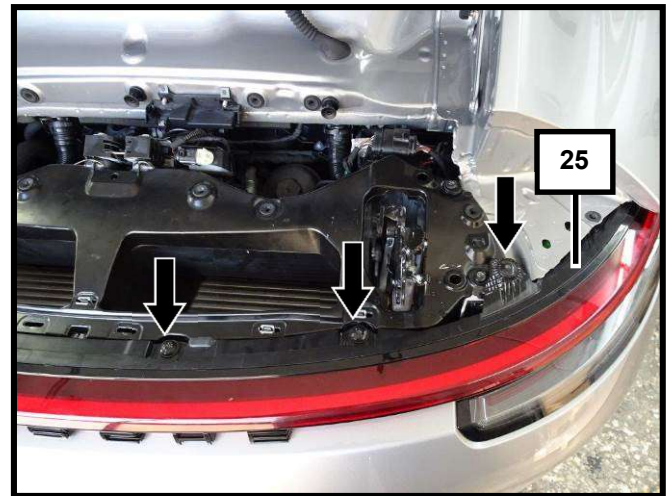

Fig. 33

- 16 Untighten the screw of the taillight.  
 17 Remove the screws of the rear apron.  
 18 Separate the electrical connection of the rear spoiler.



Fig. 34

- 19 Unscrew the complete rear spoiler unit ((23) with the carrier (20) and twist to pull out towards the top.

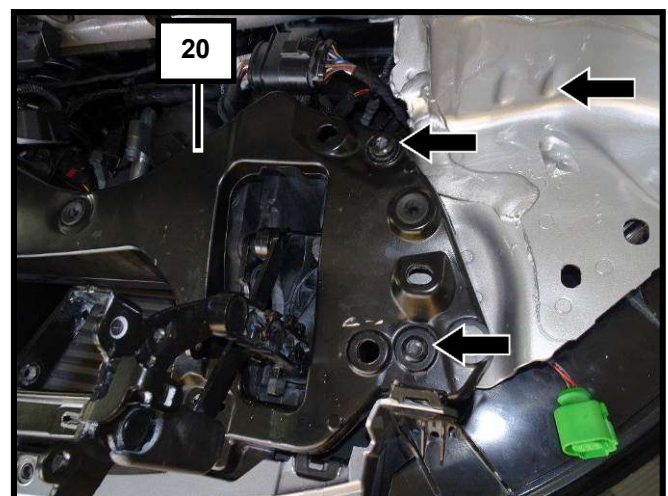

Fig. 35

- 20 Unscrew the rear spoiler unit (23) from the carrier (20).

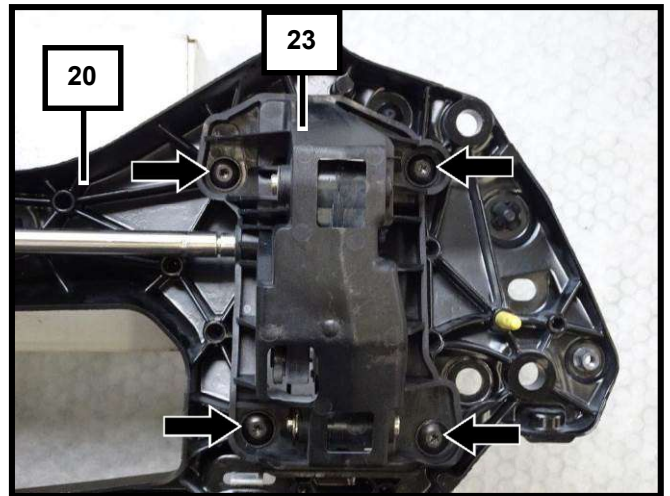

Fig. 36

- 21 Untighten the drive motor (26) from the carrier (20).

- 22 Unplug the electrical connection from the drive motor (21).

- 23 Cut the cable of the drive about 20mm behind the cable sleeve and seal watertight with the heat-shrinking tube 3.2/1.6 thin-walled (16).

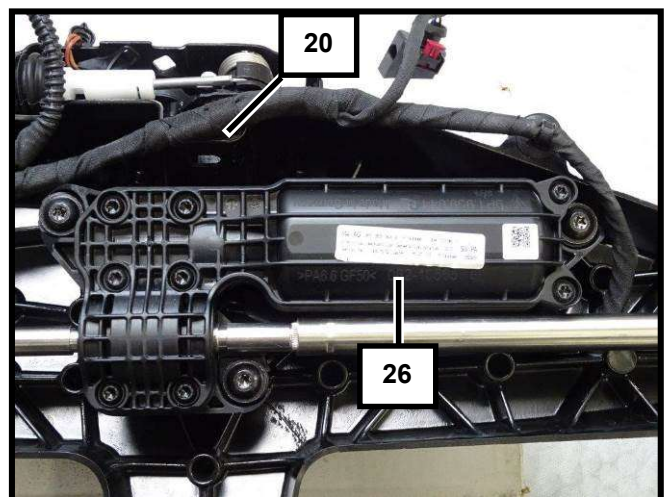

Fig. 37

- 24 Dismantle the Hall sensor (27) of the rear spoiler unit (20).

- 25 Secure the Hall sensor (27) and the cable from the drive motor with cable ties to the wiring harness.

**i** Drive unit with drive motor is no longer needed.

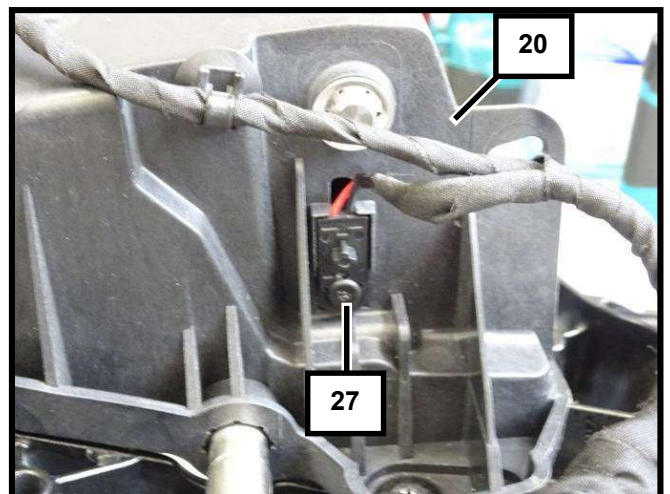

Fig. 38





# ASSEMBLY INSTRUCTIONS

## TECHART Aero-Kit for 992 Carrera

- 26 Dismantle both centered retaining clips from the carrier (20).

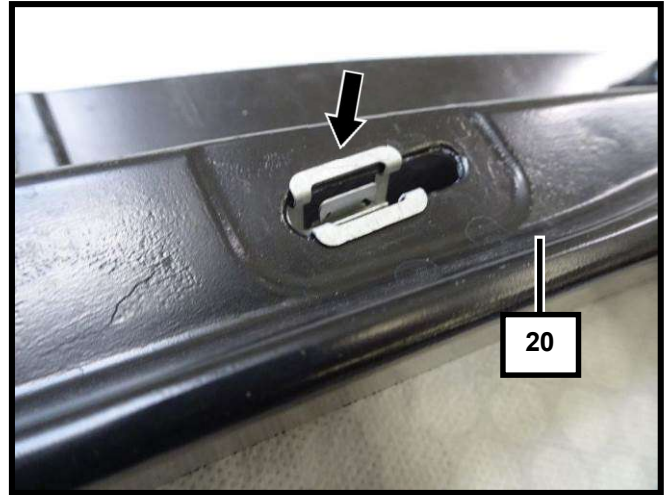

Fig. 39

- 27 Connect the TECHART bracket base frame center 092.100.810.302 (28) with the socket screws M6x16, washer 6.4x15 and the nut M6 with wave washer to the carrier (20) (slant to the back).

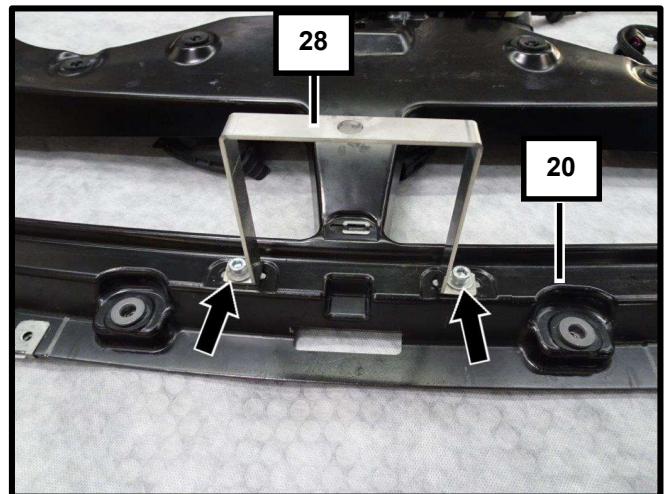

Fig. 40

- 28 Fasten the TECHART bracket base frame right and left 092.100.810.30\_ (29) with the hexagon socket head screws M8x25 and the nut M8 self-locking and washer 8x25 Coupe (or 8x20 Cabriolet) to the carrier (20) (all the way to the back).

- 29 Attach the speed nuts M8 to the TECHART bracket base frame right (29R), left (29L) and center (28).

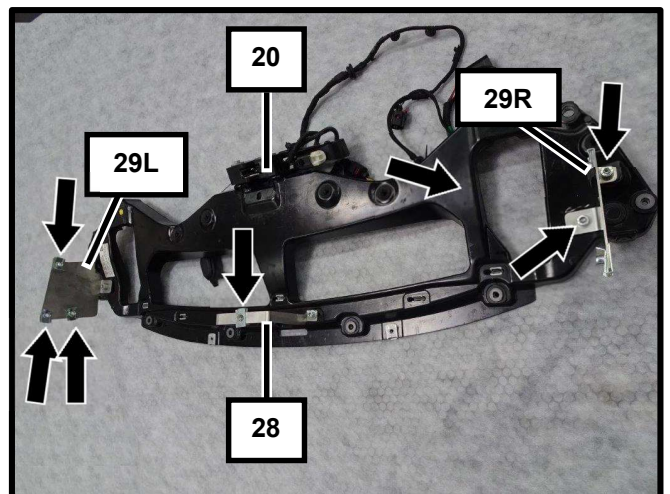

Fig. 41



- 30 Dismantle the center-mounted brake lamp (30).
- 31 Separate the electrical connection.

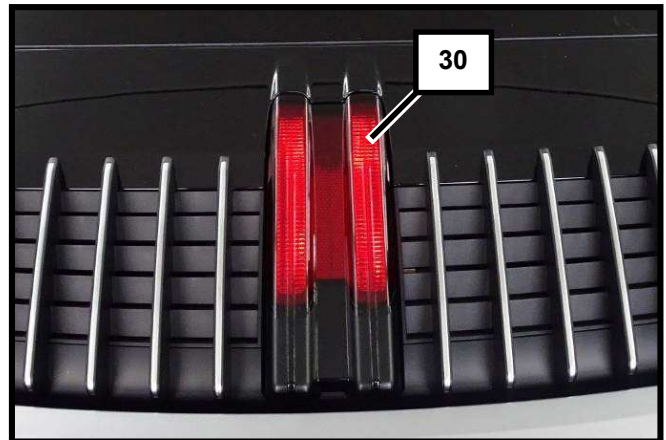

Fig. 42

Coupe:

- 32 Pinch of the cable about 20mm behind the plug.
- 33 Pull the wiring harness of the center-mounted brake lamp (31) from the service hatch and route to the plug rear spoiler (maintenance area right). For that twist the rubber sleeve at the metal sheet.
- 34 Reinstall the center-mounted brake lamp (30).



Fig. 43

Cabriolet:

- 35 Set the convertible top in service position.
- 36 Pinch off the red-white cable of the center mounted brake lamp below the hinge of the top cover. Extend it with the supplied butt connector transparent and the red-black cable and route it below the lining to the right to the plug in the engine compartment.

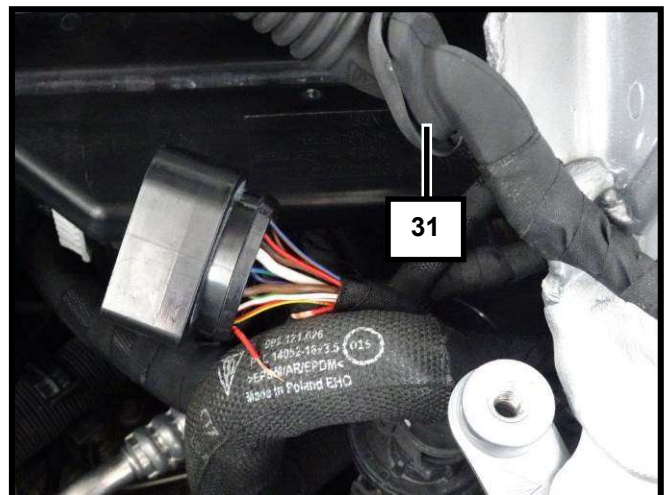

Fig. 44

- 37 Separate the cable red Pin 1 about 20mm in front of the 14-way plug at the vehicle.

- 38 Clamp the cable black/red of the wiring harness of the center-mounted stop lamp (31) to the separated cable (Fig. 43); all 3 together.
- 39 Reinstall the carrier (20).

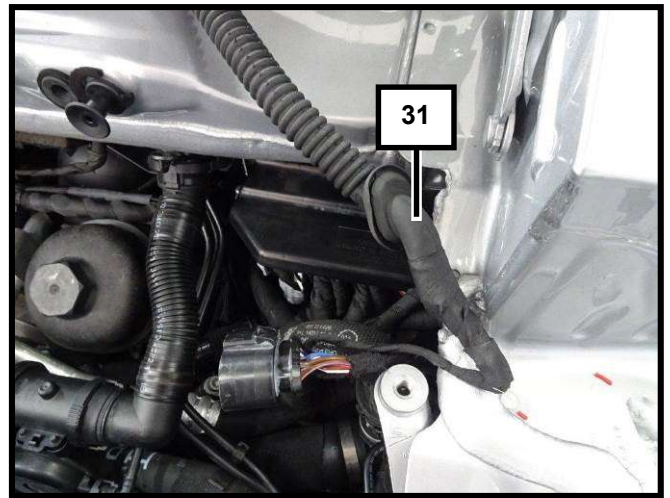

Fig. 45

- 40 Fasten the nut with wave washer M6 to the rubber-metal-stopper 000.921.10108455 (32).

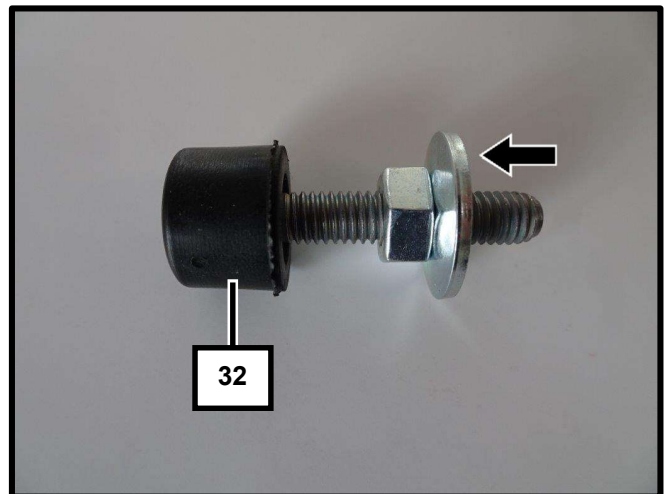

Fig. 46

- 41 Tighten the stopper M6x25/13.5 (32) with the TECHART bracket Z buffer stop 092.100.810.310 right (33) and left to the TECHART base frame (34).

**i** Care for an accurate fit.  
If necessary, install the right bracket twice.

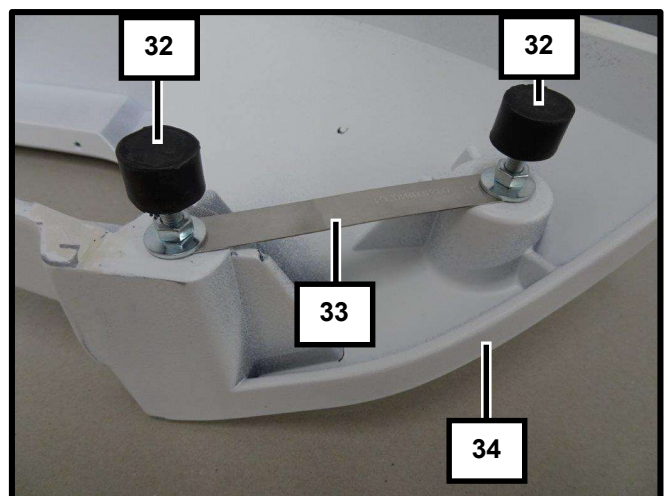

Fig. 47

42 Tighten the TECHART bracket Z buffer stop right 092.100.810.304 and left .305 (35) with the screw M5x16 to the TECHART base frame (34) and secure from the rear with the nut M6 self-locking.

43 Slide the stopper (32) into the TECHART bracket (40) and secure with the nut M6 self-locking.

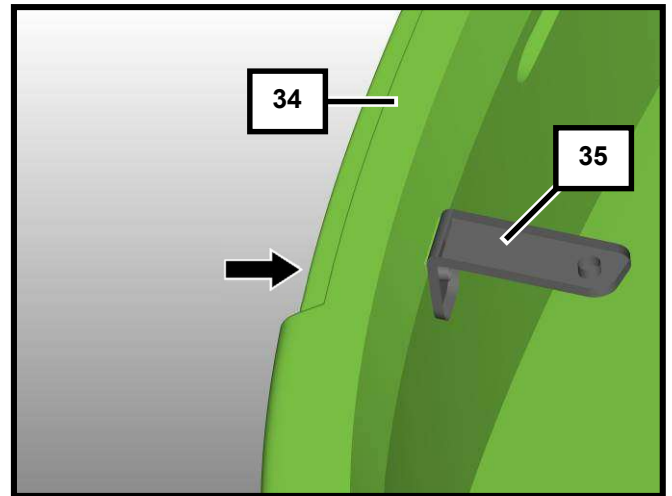

Fig. 48

44 Align the TECHART base frame (34) to the vehicle, for that adjust the stopper in such way that it fits to the side part, gap about 1mm.

**Adjust the height with the stoppers (32) (Fig. 47 and 48) in such way that the base frame fits perfectly.**

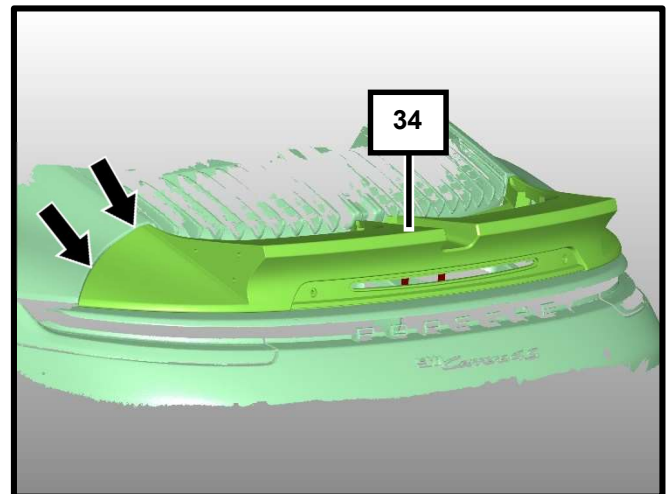

Fig. 49

45 Fasten the TECHART panel air intake right 092.100.810.110 (36) and left .111 (37) with the screws 5x16 and the serrated washer 5.0 in the TECHART base frame 092.100.810.100 (34).

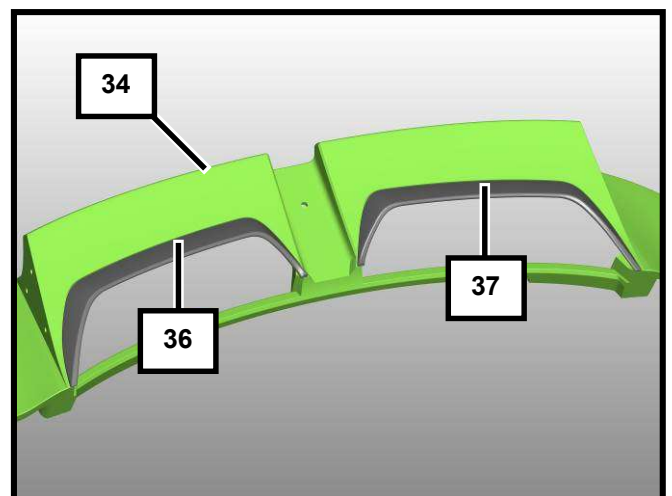

Fig. 50



- 46 Apply PU-adhesive to the outer side of the TECHART inner part top right 092.100.810.130 (38) and left .131 (39).
- 47 Glue the TECHART inner part top right (38) and left (39) in the TECHART panel air intake right (36) and left (37).

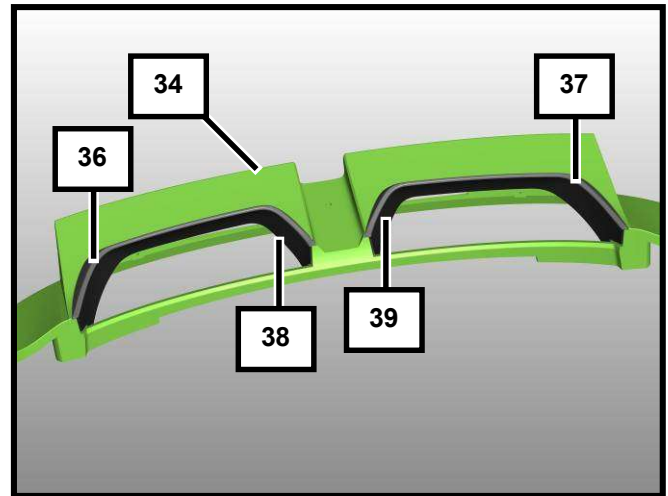

Fig. 51

**i** Press on firmly in areas coated with adhesive. Check for an accurate fit – Immediately remove any PU adhesive that escapes using a cleaning agent.

- 48 Attach the TECHART grille 092.100.810.600 (40) to the TECHART inner part top right (38) and left (39).

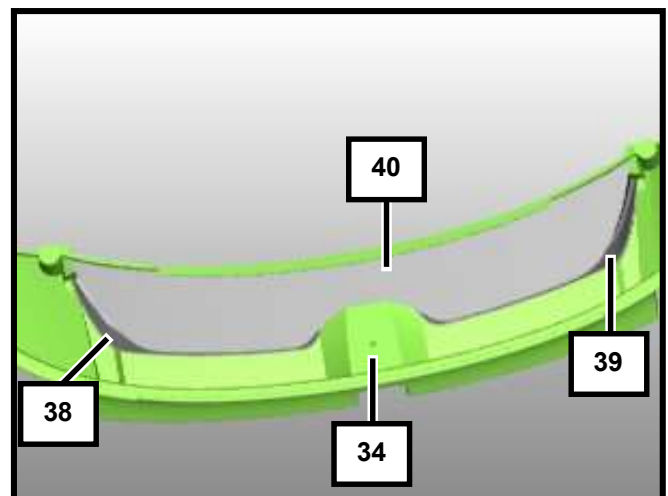

Fig. 52

- 49 Attach the TECHART inner part bottom 092.100.810.132 (41) to the TECHART grille (40) and tighten with the screws 5x16 and the serrated washer 5.0 to the TECHART inner part right (38), left (39) and the TECHART base frame (34).
- 50 Tighten the TECHART grille (40) with two screws 5x16 and the serrated washers 5.0 to the TECHART base frame (34).

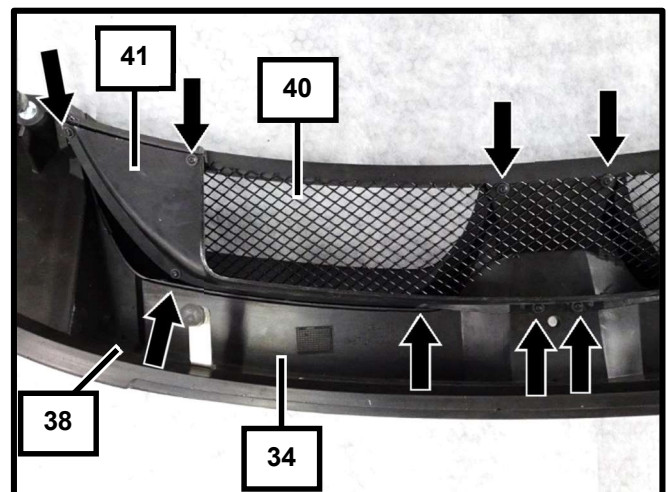

Fig. 53

- 51 Glue the TECHART center-mounted stop lamp 092.180.810.009 (42) watertight into the TECHART base frame (34).

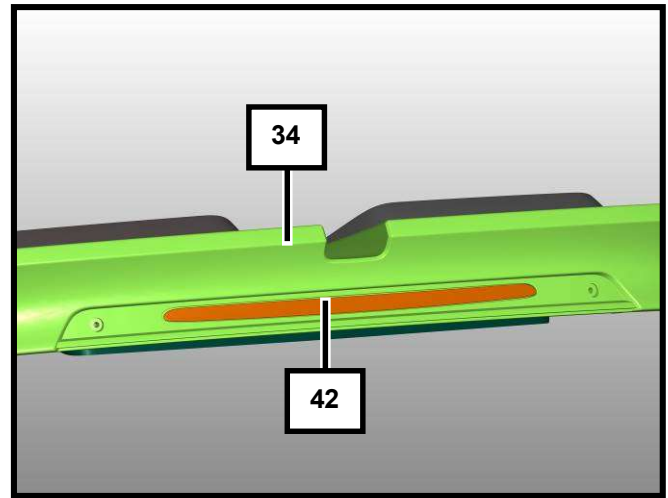

Fig. 54

- 52 Apply PU-adhesive to the outer side of the TECHART frame 092.100.810.101 (43).
- 53 Glue the TECHART frame (43) to the TECHART base frame (34).



**Press on firmly in areas coated with adhesive. Check for an accurate fit – Immediately remove any PU adhesive that escapes using a cleaning agent.**

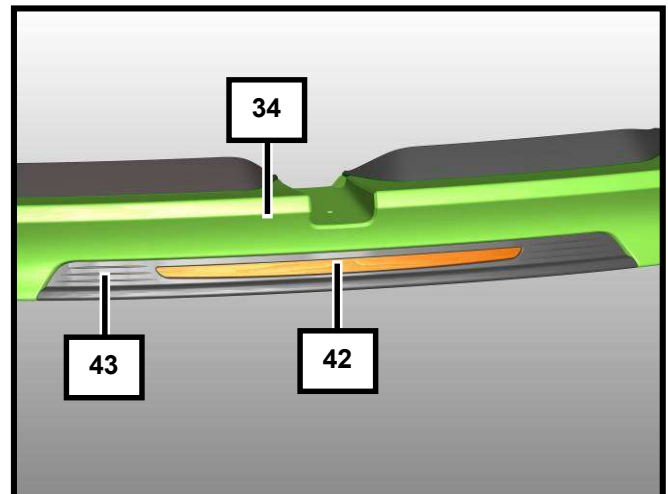

Fig. 55

- 54 Attach the TECHART base frame (34) with all add-on parts to the vehicle and connect the electrical connection of the center-mounted stop lamp.



**Check all 7 speed nuts M8 at the TECHART bracket to their correct position.**

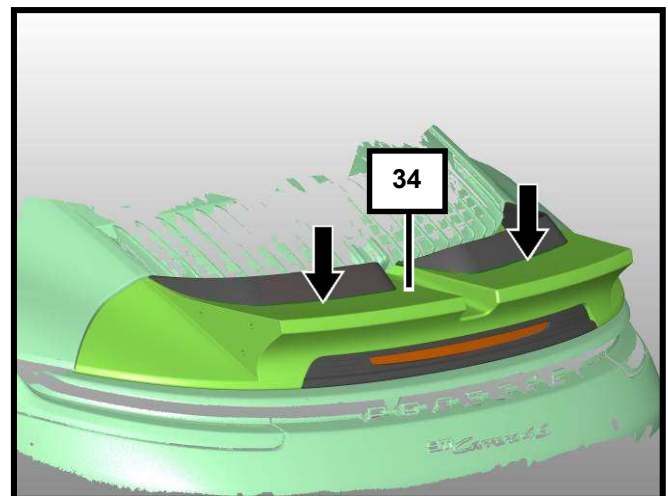

Fig. 56



- 55 Tighten the TECHART wing profile right 092.100.810.200 (44) and left .201 (45) with the screws M8x70 to the TECHART base 092.100.81\_.220 (46).

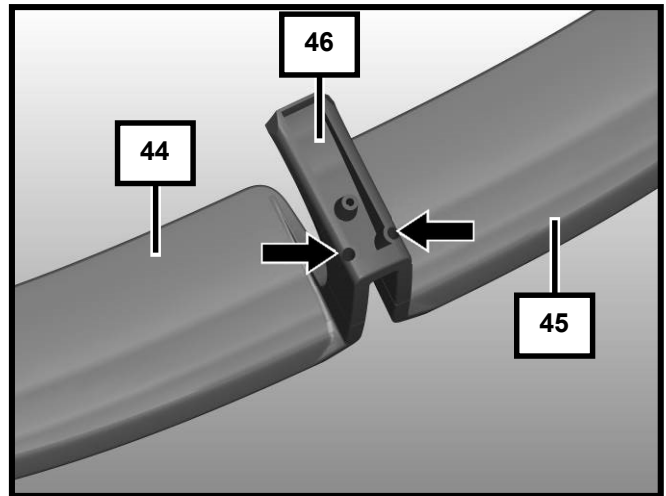

Fig. 57

- 56 Tighten the TECHART Makrolon mounting plate right 092.120.81\_.204 (47) and left .205 (48) to the TECHART profiles right (44) and left (45) with the screws M6x18, the washers and the cap nuts M6. Set the cap nuts on the profile side, not on the TECHART Makrolon mounting plate.

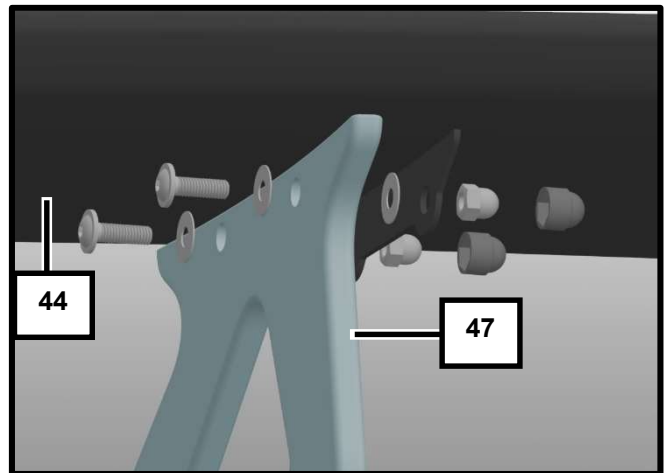

Fig. 58

- 57 Attach the protection caps on the speed nut.

- i** Tighten the cap nuts with bolt adhesive. The bolt adhesive must not contact the TECHART Makrolon mounting plates. Tightening torque = 6 Nm

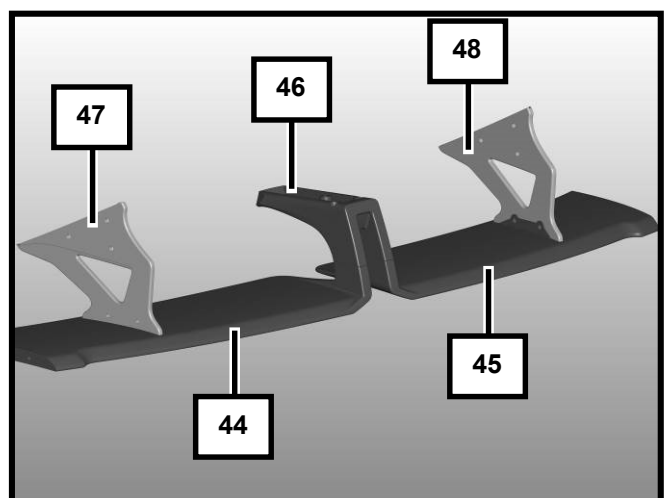

Fig. 59

- 58 Attach the TECHART profiles with the base and mounting plates to the base frame (34).

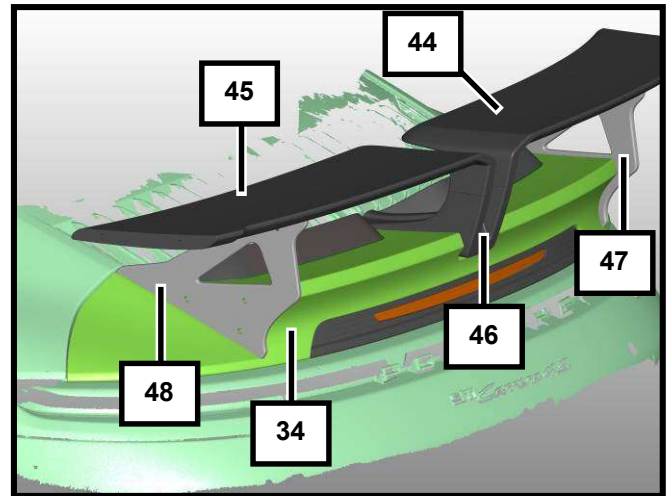

Fig. 60

- 59 Set the TECHART insert Makrolon mounting plates right 092.120.810.224 and left .225 (49) into the TECHART Makrolon mounting plates.

- 60 Attach the TECHART rear spoiler with the screws M8x40 through the TECHART insert mounting plates (49) and base frame (34) to the bracket base frame (29), do not tighten the screws, yet.

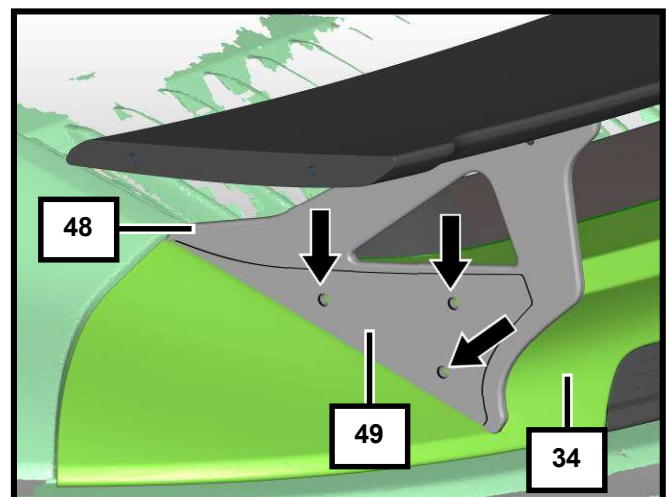

Fig. 61

**i** Only install the TECHART insert mounting plate (49), if the inside is painted, page 12 1.1 point 4.

- 61 Fasten the TECHART base (46) with the screws M8x60 through TECHART base frame (24) to the TECHART bracket base frame center (28), do not tighten, yet.

- 62 Align the TECHART rear spoiler and then tighten all 7 screws M8 (see position: arrows on fig. 61 and 62) using bolt adhesive. Tightening torque = 8 Nm

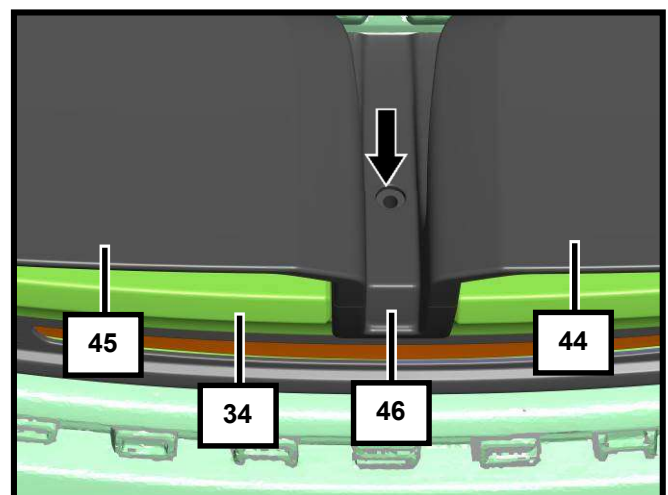

Fig. 62

- 63 Tighten the TECHART rear spoiler panel right 092.100.810.210 and left .211 (51) with the screws M8x16 to the TECHART profile right (44) and left (45) using bolt adhesive. Tightening torque = 4 Nm

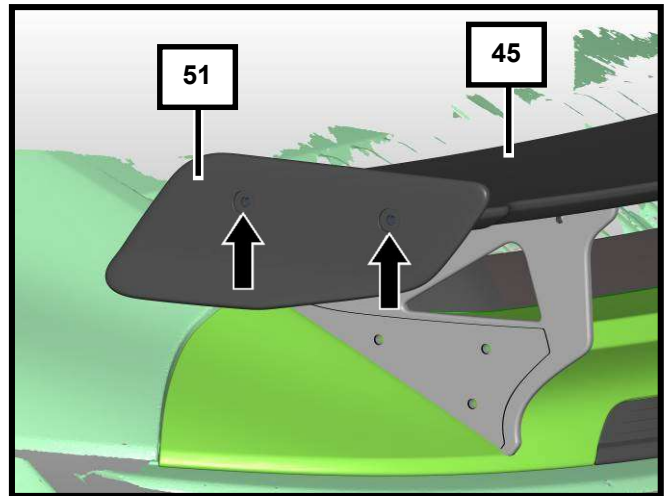

Fig. 63

- 64 Apply PU-adhesive to the bonding surfaces of the TECHART cover for the center-mounted stop lamp 092.100.810.500 (52).

- 65 Glue TECHART cover for the center-mounted stop lamp (52) to the original high-mounted stop lamp (30).

- i** Press on firmly in areas coated with adhesive. Check for an accurate fit – Immediately remove any PU adhesive that escapes using a cleaning agent.

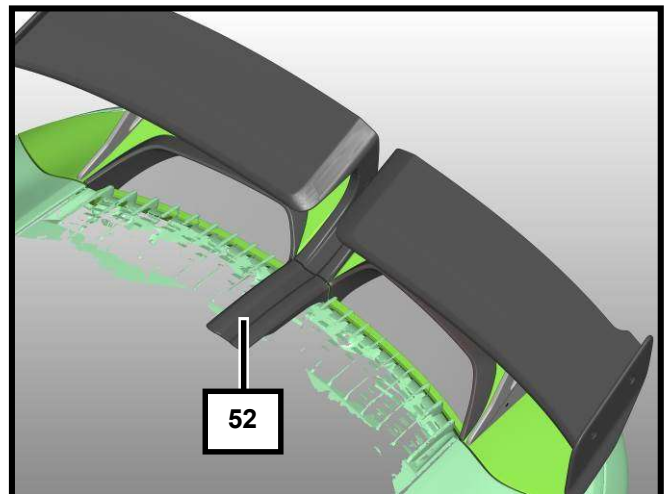

Fig. 64

- 66 Fold the rear seat.
- 67 Lift the carpet of the parcel shelf to the top.
- 68 Remove the 4-pole plug from the control unit rear spoiler (53).

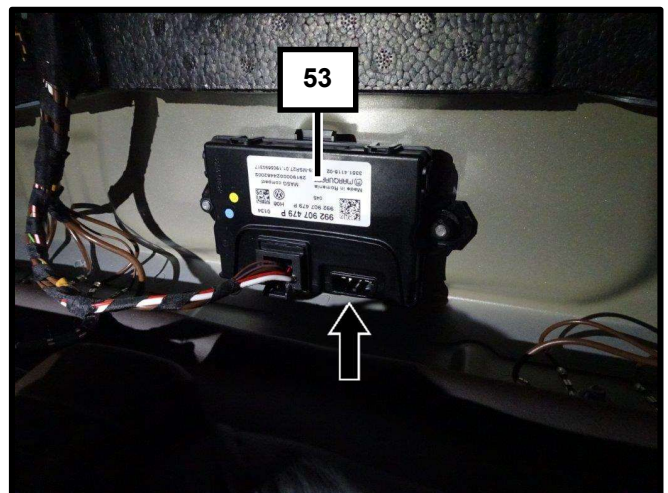

Fig. 65



- 69 Open the plug (54).
- 70 Unpin all 4 pins with the supplied tool from the plug (54).
- brown 0.75mm
  - green
  - red / white
  - brown 2mm

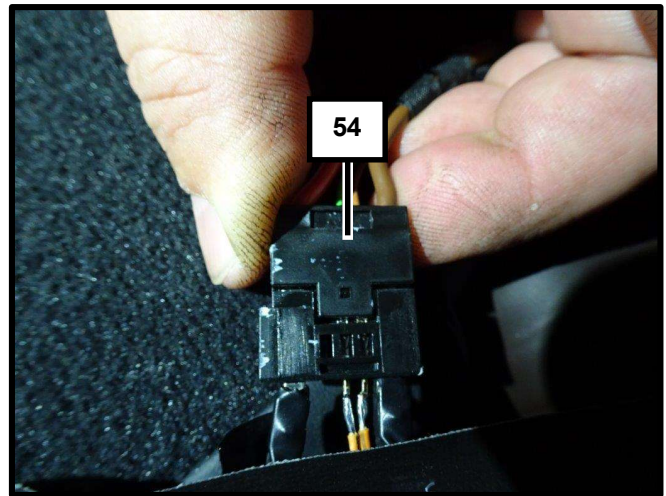

Fig. 66

- 71 Pin the red / white cable into the TECHART plug gray 3-fold (55) pin 2.
- 72 Pin the brown cable 2mm into the TECHART plug gray 3-fold (55) pin 1.
- 73 Pin 3 stays void.

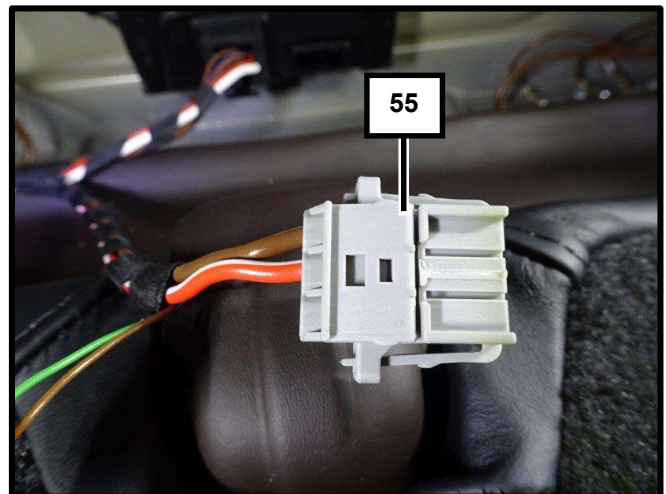

Fig. 67

- 74 Pin the green cable into the TECHART plug 3-fold (56) pin 2.
- 75 Pin the brown cable 0.75mm into the TECHART plug 3-fold (56) pin 1.
- 76 Pin 3 stays void.

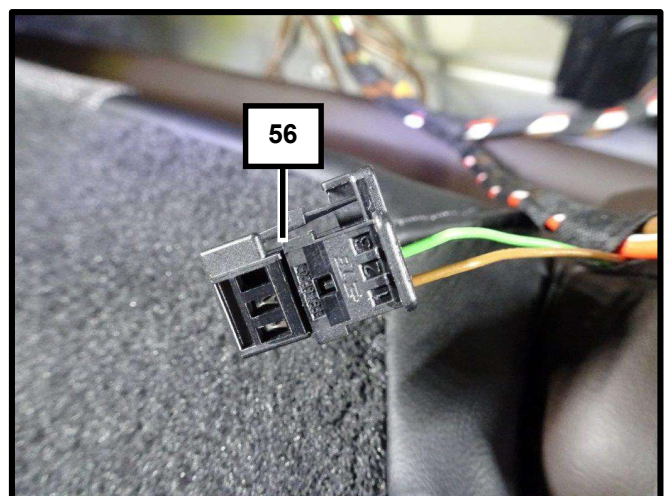

Fig. 68



# ASSEMBLY INSTRUCTIONS

## TECHART Aero-Kit for 992 Carrera

- 77 Insert both plugs into the TECHART wiring harness.
- 78 Insert the TECHART wiring harness into the TECHART control unit.
- 79 Stick both plugs (55+56) to a hook and loop tape.

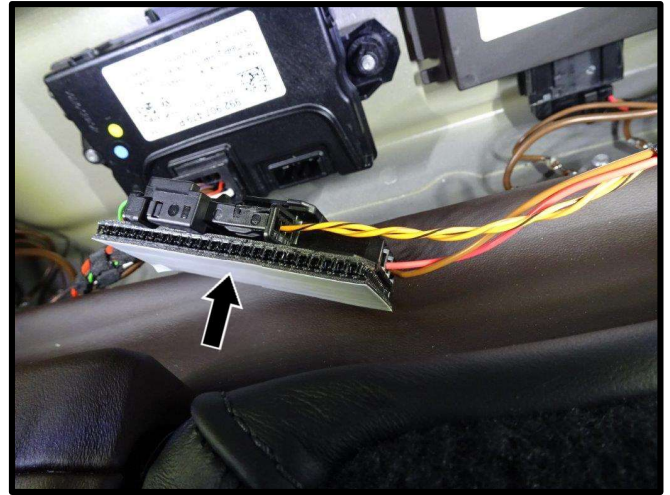

Fig. 69

- 80 Stick the TECHART control unit (57) with the hook and loop tape next to the control unit rear spoiler (53).
- 81 Stick the TECHART plugs (55+56) near the control unit rear spoiler (53).
- 82 Set the carpet of the parcel shelf back down.
- 83 Fold the rear seats back.

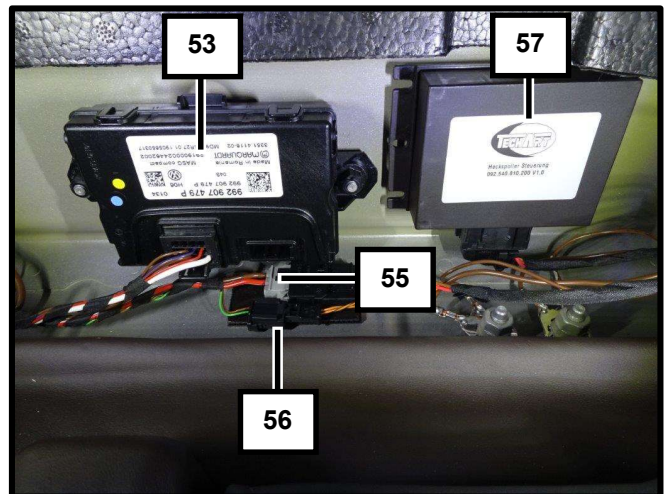

Fig. 70



The plug at the control unit rear spoiler stays void.





# ASSEMBLY INSTRUCTIONS

## TECHART Aero-Kit for 992 Carrera

---

### 3 Final check

- 1 Perform a general function check on vehicle. Check the illumination.

### 4 Self-help

- 1 Ignore the errors at the PIWIS „Aero-dynamic control unit“.



# ASSEMBLY INSTRUCTIONS

**TECHART Aero-Kit for 992 Carrera**

---



**TECHART AUTOMOBILDESIGN GMBH**

RÖNTGENSTRASSE 47

71229 LEONBERG / GERMANY

TEL +49 7152 / 9339- 0

FAX +49 7152 / 9339-33

[info@techart.de](mailto:info@techart.de)

[www.techart.de](http://www.techart.de)

*Subject to change at any time without prior notice.*  
Copyright 2021 by **TECHART** Automobildesign GmbH