



# ASSEMBLY INSTRUCTIONS

## TECHART Aero-Kit for 991 Carrera

Consisting of:

Part-no. 091.100.100.009	Front spoiler
Part-no. 091.100.340.009	Side skirts Carrera 2 / 2S
Part-no. 091.100.350.009	Side skirts Carrera 4 / 4S
Part-no. 091.100.800.009	Rear spoiler I
Part-no. 091.100.810.009-02	Rear spoiler II

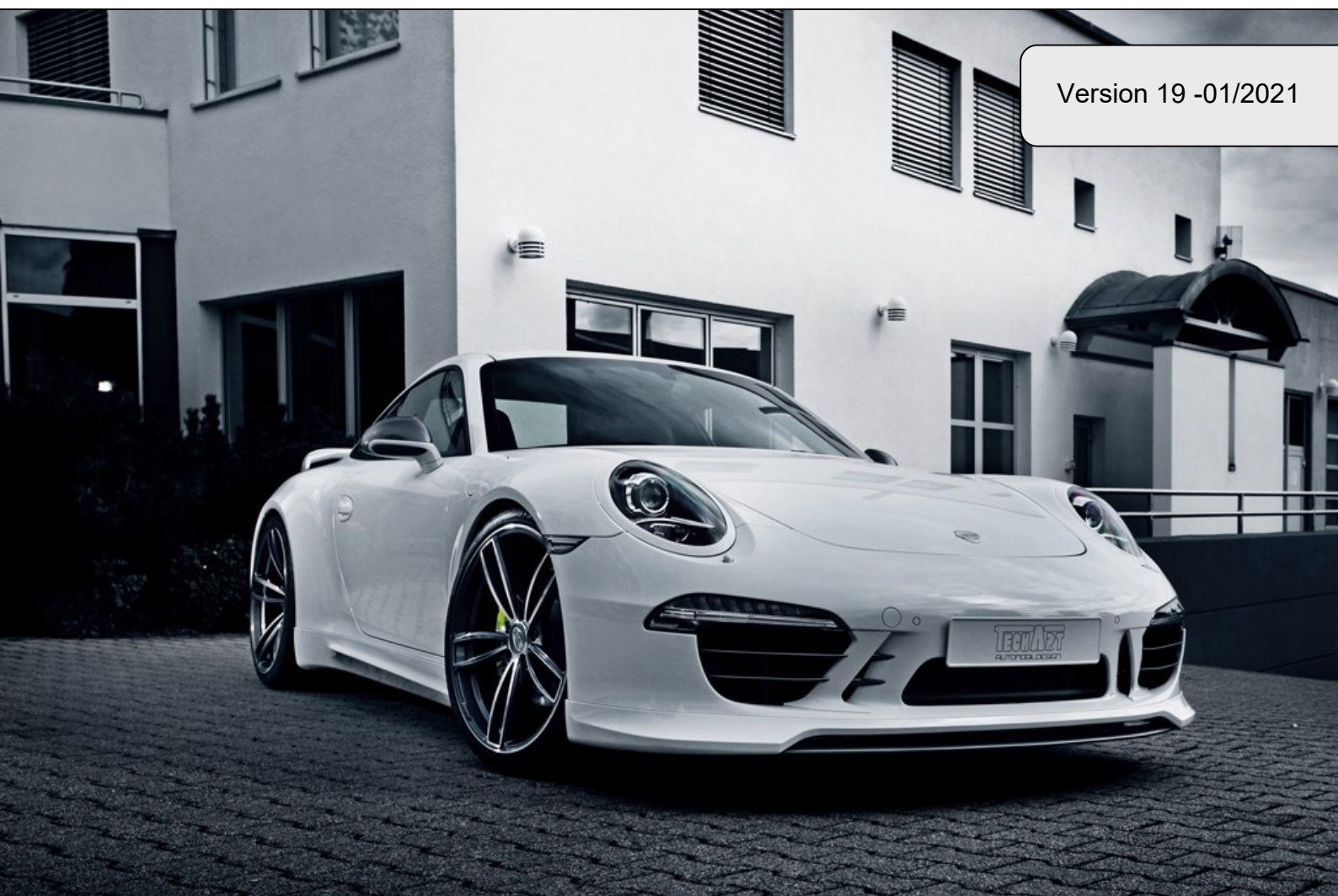

Version 19 -01/2021



# ASSEMBLY INSTRUCTIONS

## TECHART Aero-Kit for 991 Carrera

### Contents

<b>I</b>	<b>Important safety information .....</b>	<b>3</b>
<b>II</b>	<b>Preparation .....</b>	<b>4</b>
<b>III</b>	<b>Installation .....</b>	<b>9</b>
1	Prepare vehicle .....	9
1.1	Remove wheels and detachable parts .....	9
2	TECHART Aerokit for 991 Carrera .....	9
2.1	Preliminary work front spoiler .....	7
2.2	Install TECHART front spoiler .....	8
2.3	Preliminary work side skirt .....	11
2.4	Install TECHART side skirts .....	12
2.5	Install TECHART rear spoiler I .....	14
2.6	Install TECHART rear spoiler II .....	16
3	Final check .....	23



















# ASSEMBLY INSTRUCTIONS

## TECHART Aero-Kit for 991 Carrera

### I Important safety information











All of the necessary work must be performed by qualified persons with an appropriate level of expertise.

	<p style="text-align: center;"> <b>WARNING</b></p> <p>Vehicle lifts with an insufficient lifting capacity can collapse under the weight of the vehicle and crush any persons standing underneath.</p> <p>Compare the weight of the vehicle with the lifting capacity of your vehicle lift. The weight of the vehicle must not exceed the lifting capacity of your vehicle lift. The weight of the vehicle can be found in the vehicle operating manual.</p>	
	<p style="text-align: center;"> <b>WARNING</b></p> <p>Risk of injury from electric current.</p> <p>Switch off the ignition and disconnect the battery when working on the vehicle electrical/electronics systems.</p>	
   	<p style="text-align: center;"> <b>WARNING</b></p> <p>Risk of fire and explosion from ignition of windshield cleaning agents/antifreeze and their vapors.</p> <p>Risk of poisoning from ingesting windshield cleaning agents/antifreeze and breathing in their vapors.</p> <p>Risk of injury due to irritation caused by windshield cleaning agents/antifreeze coming into contact with eyes, skin and other parts of the body.</p> <p>Wear protective clothing and safety glasses. Avoid naked flames, fire and sources of ignition. Avoid contact with eyes, skin and other parts of the body. Do not eat, drink or smoke when handling windshield cleaning agents/antifreeze. Do not breathe in vapors and ensure adequate ventilation. Keep windshield cleaning agents/antifreeze only store them in sealable original containers.</p> <p style="text-align: center;">  </p>	  



# ASSEMBLY INSTRUCTIONS

TECHART Aero-Kit for 991 Carrera

 	 <b>CAUTION</b>	 
	<p>Risk of injury from hands and arms being crushed, cut or lacerated when working with sharp-edged and bulky objects.</p> <p>Wear protective clothing and protective gloves. Keep limbs out of narrow and inaccessible areas of the vehicle and/or avoid dangerous situations by using special tools and suitable aids.</p>	
	 <b>CAUTION</b>	
	<p>Risk of injury to back, muscles, joints, tendons and ligaments from lifting and carrying heavy and/or bulky objects.</p> <p>Lift and transport heavy and/or bulky objects with the help of other people and/or with suitable aids.</p>	
	<b>NOTICE</b>	
	<p>Before starting the assembly procedure, carefully read the assembly instructions in full and pay attention to the safety information and sequence of the individual operation steps.</p>	
	<b>NOTICE</b>	
	<p>All body parts must be prepared and painted in accordance with the attached painting guide.</p>	

## II Preparation

### Number of people required

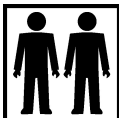

For the installation of this product at least two persons are needed.

### Help and support

If you have any technical queries, please contact us immediately:  
[support@techart.de](mailto:support@techart.de)



# ASSEMBLY INSTRUCTIONS

## TECHART Aero-Kit for 991 Carrera

### Check TECHART Aerokit I parts kit for completeness

<b>1</b>	<b>091.100.100.009</b>	<b>Front spoiler I</b>
Consisting of:		
1	091.100.100.100	Front spoiler
1	091.100.100.110	Splitter
1	091.100.100.111	Carrier
21	000.100.999.999	Collar bolt for plastic PT 50x16 with cone point
7	0039004.2X951025	Sheet metal screw fillister head with flange 4.2x9.5
2	0039004.8X327981	Collar bolt 4.8x32, black
1	00091089010031	Bond and Seal, 70ml tube
1	091.140.100.009	Set stone protective foil

<b>1</b>	<b>091.100.340.009</b>	<b>Side skirts 2 / 2S</b>
Consisting of:		
1	091.100.340.100	Side skirt right
1	091.100.340.101	Side skirt left
1	091.100.340.110	Side skirt bottom part right
1	091.100.340.111	Side skirt bottom part left
16	99950764009	U-clip
16	0029004.8/19.0X12.7	Speed nut, automobile 19mm x 4.8mm
32	000.100.999.998	Collar bolt 4.8x16
2	000.100.999.999	Collar bolt for plastic PT 50x16 with cone point
2	00091089010031	Bond and Seal, black, 70ml tube
1	091.140.340.009	Set stone protective foil

<b>1</b>	<b>091.100.350.009</b>	<b>Side skirts 4 / 4S</b>
Consisting of:		
1	091.100.350.100	Side skirt right
1	091.100.350.101	Side skirt left
1	091.100.350.110	Side skirt bottom part right
1	091.100.350.111	Side skirt bottom part left
16	99950764009	U-clip
16	0029004.8/19.0X12.7	Speed nut, automobile 19mm x 4.8mm
32	000.100.999.998	Collar bolt 4.8x16
2	000.100.999.999	Collar bolt for plastic PT 50x16 with cone point
2	00091089010031	Bond and Seal, black, 70ml tube
1	091.140.340.009	Set stone protective foil





# ASSEMBLY INSTRUCTIONS

## TECHART Aero-Kit for 991 Carrera

<b>1</b>	<b>091.100.800.009</b>	<b>Rear spoiler I</b>
Consisting of:		
1	091.100.800.100	Rear spoiler
4	001900M5X12A27380	Fillister head screw M 5x12 stainless steel A2
1	00091089010073	Bond and Seal black, 300ml tube
1	091.100.800.500	Drilling template

optionally

<b>1</b>	<b>+91.100.800.000</b>	<b>V01: Rear spoiler " + "</b>
Consisting of:		
1	091.100.800.200	Base extension right
1	091.100.800.201	Base extension left
4	001900M05X40912	Hexagon socket head screw, M 5x40, galvanized
4	001900M05X15A2	Washer, M 5x15, A2

<b>1</b>	<b>091.100.810.009-02</b>	<b>Rear spoiler II</b>
Consisting of:		
1	091.100.810.100	Base frame
1	091.100.810.101	Base frame hood
1	091.100.810.200	Wing profile
1	091.100.810.300	Rear bracket
1	091.100.810.301	Bracket stop light
2	091.100.810.311	Bracket front top base frame
2	091.100.810.312	Bracket front bottom base frame
1	091.100.810.400	Bracket right, base frame support
1	091.100.810.401	Bracket left, base frame support
<b>1</b>	<b>091.100.810.990ZB</b>	<b>Set mounting material</b>
Consisting of:		
2	000.100.999.999	Collar screw for plastic PT 50x16 with cone point
18	001900M5X16A27380	Fillister head screw M 5x16 stainless steel A2
2	001900M6X307380A2	Fillister head screw with flange M 6x30 / A2
4	001900M05X107380	Hexagon socket head screw, M 5x10, flange black galvanized
4	001900M05X10912A	Cylinder head screw, M5x10, (A2/70)
2	001900M05X16912A	Cylinder head screw, M 5x16, (A2/70)
4	001900M05X15	Washer fender, M 5x15, galvanized
2	001900M05	Speed nut, M 5
16	001900M056798	Serrated washer 5.0 with external teeth -DIN 6798 M5
2	95555958600	Sleeve
2	99950758401	Fixing clip
1	091.100.810.500	Cover center mounted brake lamp
1	0005905555161	Butt connector watertight red 0.5 – 1.5 mm²
1	00091955069510	Hook tool



# ASSEMBLY INSTRUCTIONS

## TECHART Aero-Kit for 991 Carrera

### Parts-kit options for rear spoiler II

<b>1</b>	<b>+91.100.800.005</b>	<b>V01: for Coupe / Convertible Carrera</b>
Consisting of:		
1	091.100.810.210	Rear spoiler II, base plate right, short
1	091.100.810.211	Rear spoiler II, base plate left, short
1	091.100.810.220	Rear spoiler II, base right, long
1	091.100.810.221	Rear spoiler II, base left, long
1	091.100.810.222	Rear spoiler II, base plate right, long
1	091.100.810.223	Rear spoiler II, base plate left, long
4	001900M8X907380A2	Fillister head screw with flange M 8x90 A2
4	001900M8X307380A2	Fillister head screw with flange M 8x30 / A2

or

<b>1</b>	<b>+91.100.810.010</b>	<b>V01: for Coupe with catch-rope kit</b>
Consisting of:		
1	091.100.810.220S	Rear spoiler II, base right, long, Switzerland
1	091.100.810.221S	Rear spoiler II, base left, long, Switzerland
1	091.100.810.222S	Rear spoiler II, base plate right, long, Switzerland
1	091.100.810.223S	Rear spoiler II, base plate left, long, Switzerland
4	000900848800	Hexagon socket head screw, M 8x80
2	0001002520520	Plastic screw DIN 912 M5x20
1	000100880150	Catch-rope for rear spoiler II
2	091100881302	Decal version V01 Coupe
4	001900M8X907380A2	Fillister head screw with flange M 8x90 A2

or

<b>1</b>	<b>+91.100.810.006</b>	<b>V01: for Convertible high bases Carrera w/o TÜV</b>
Consisting of:		
1	091.100.881.210	Rear spoiler II, base plate right Convertible
1	091.100.881.211	Rear spoiler II, base plate left Convertible
4	001900M8X907380A2	Fillister head screw with flange M 8x90 A2



# ASSEMBLY INSTRUCTIONS

## TECHART Aero-Kit for 991 Carrera

<b>1</b>	<b>+91.100.810.200</b>	<b>V02: Profile paintable</b>
Consisting of:		
1	091.100.810.200	Rear spoiler II, wing profile

or

<b>1</b>	<b>+91.121.810.200</b>	<b>V02: Profile in Carbon graphite matt</b>
Consisting of:		
1	091.121.810.200	Rear spoiler II, wing profile

or

<b>1</b>	<b>+91.121.810.200G</b>	<b>V02: Profile in Carbon graphite shiny</b>
Consisting of:		
1	091.121.810.200G	Rear spoiler II, wing profile

Please use the table to check whether all of the required parts are present.

Once parts have been removed from their original packaging, ensure that they are properly handled and stored.



### III Installation

#### 1 Prepare vehicle

- i** Before starting work, check that the vehicle is free from defects. Use the PIWIS system tester to read out all the fault memories of the individual vehicle components and first rectify any faults displayed.

#### 1.1 Remove wheels and detachable parts

- 1 Raise vehicle at the factory-fitted jacking points.
- 2 Detach the wheels.

### 2 TECHART Aerokit for 991 Carrera

#### 2.1 Preliminary work front spoiler

- 1 Unclip the original splitter and rubber lip from the original front apron (1).

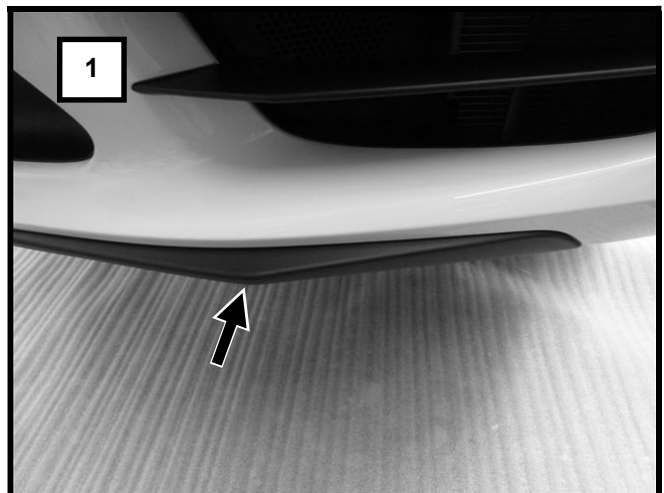

Fig. 01

- i** The original splitter and rubber lip are no longer needed.

### 2.2 Install TECHART front spoiler

- i** The bonding surfaces on the TECHART front spoiler and front apron must be dry and free from dust and paint spray mist!

Use cleaning agent to thoroughly degrease bonding surfaces on the TECHART front spoiler and front apron. Then sand it down using 100-180 grade abrasive paper and finally use cleaning agent to degrease it again.

Do not touch the surfaces after they have been cleaned.

- i** The insertion of the TECHART front spoiler to the front apron has to be blank and free of varnish!

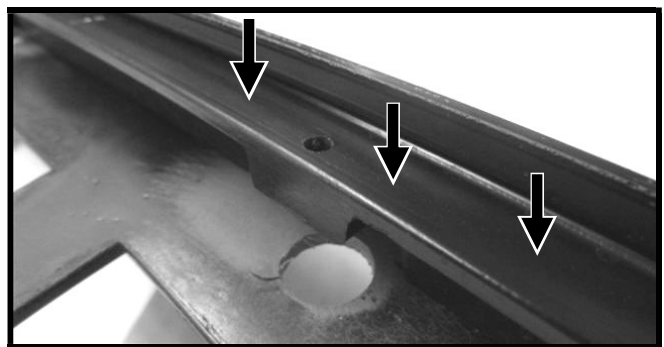

Fig. 02a

- 1 Unscrew the fixation screws left and right from the front apron.

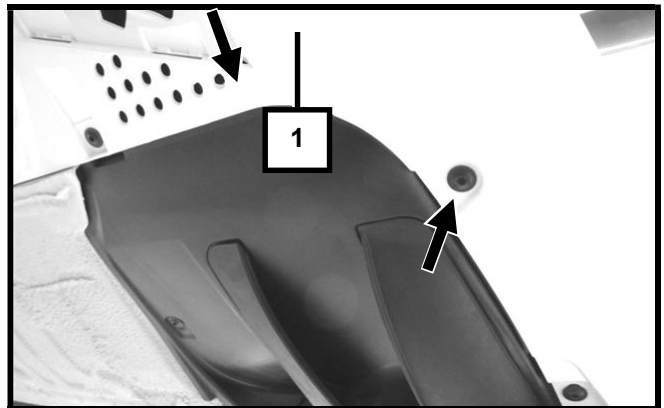

Fig. 02b

- 2 Slide the TECHART carrier 091.100.100.111 (2) into the original front apron (1) and fix it from the bottom with 4 screws 5x16, do not tighten.

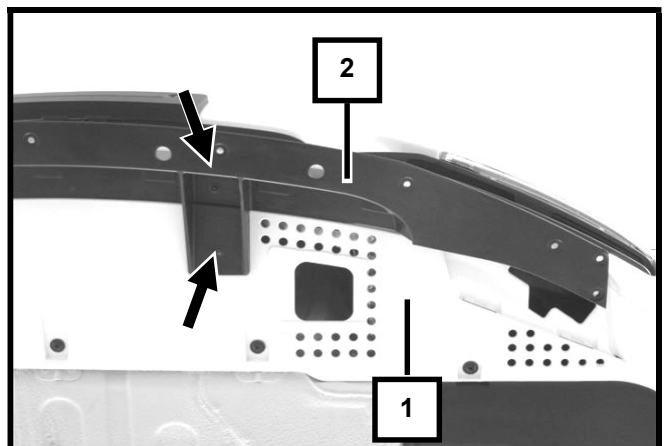

Fig. 03

- 3 Evenly apply the PU-adhesive on the bonding surface (a) of the TECHART front spoiler 091.100.100.100 (3).

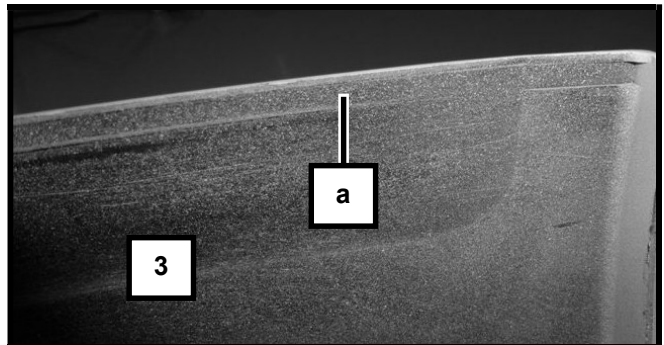

Fig. 04

- 4 Insert the TECHART front spoiler (3) into the TECHART carrier (2) and slide it on the original front apron (1).
- 5 Align the TECHART front spoiler from the center towards the outside (3).

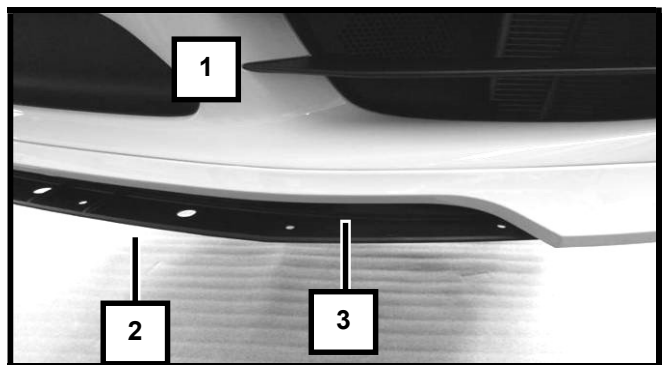

Fig. 05

**i** The TECHART front spoiler may overlap left and right up to 1mm.

This is necessary to install the TECHART front spoiler (3) tension-free.



Fig. 05a

**i** Press on firmly in areas coated with adhesive. Check for an accurate fit – Immediately remove any PU adhesive that escapes using a cleaning agent.

- 6 Tighten the TECHART front spoiler (3) from the bottom through the TECHART carrier (2) into the original front apron with the screws 5x16.
- 7 Tighten the fixing screws (see point 2).

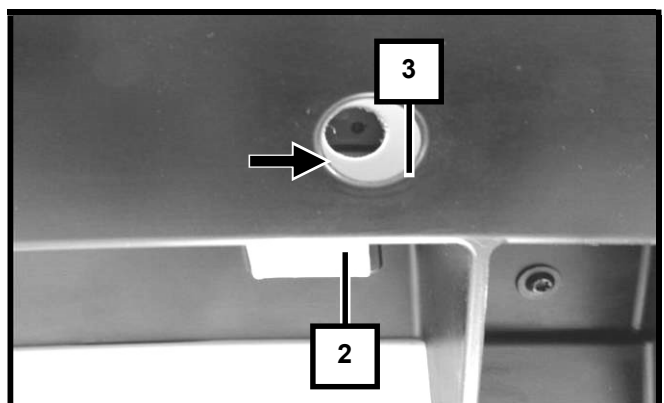

Fig. 06

- 8 Screw the TECHART carrier (2) with the screws 5x16 to the TECHART front spoiler (3).

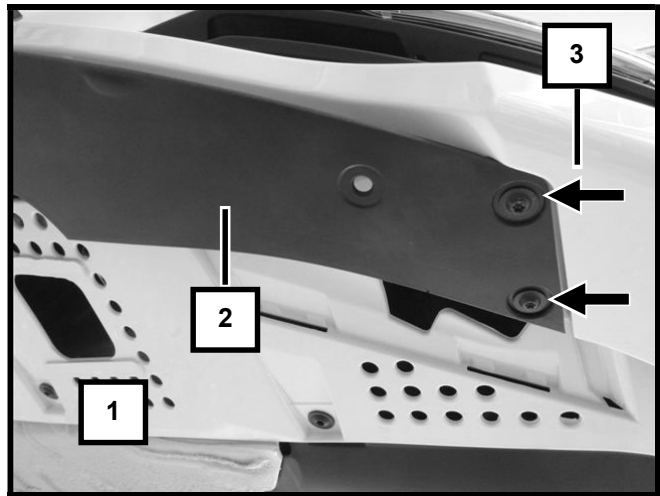

Fig. 07

- 9 Bolt the TECHART front spoiler (3) at its sides from the bottom with the screws 4.8x32 to the original fixation and additionally screw it into the original front apron with the screw 5x16, for that drill a hole with  $\varnothing$  3.5mm each.

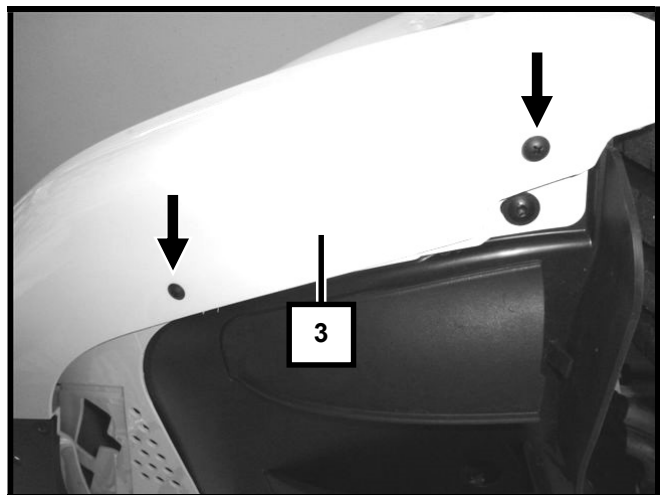

Fig. 08

- 10 Bolt the straps of the TECHART front spoiler and the TECHART carrier (2) from the bottom with the screws 5x16 into the original front apron, for that drill a hole with  $\varnothing$  3.5mm each.

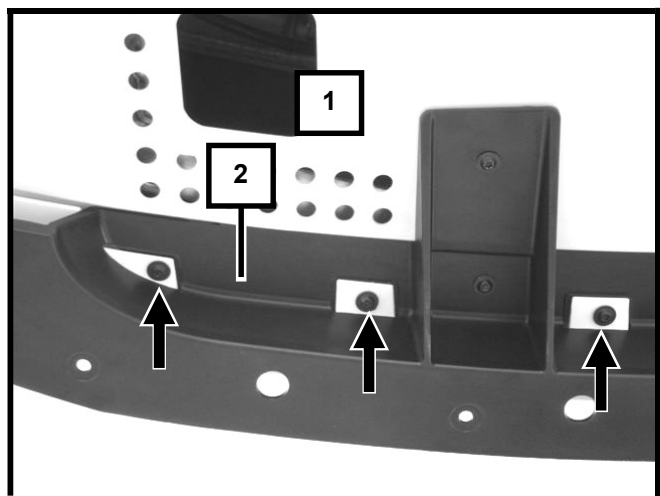

Fig. 09

- 11 Slide the TECHART splitter (4) onto the TECHART carrier (2) and tighten from the bottom with the screws 4.2 x 9.5.
- 12 Affix the stone protective foil at the area of the wheel arch.

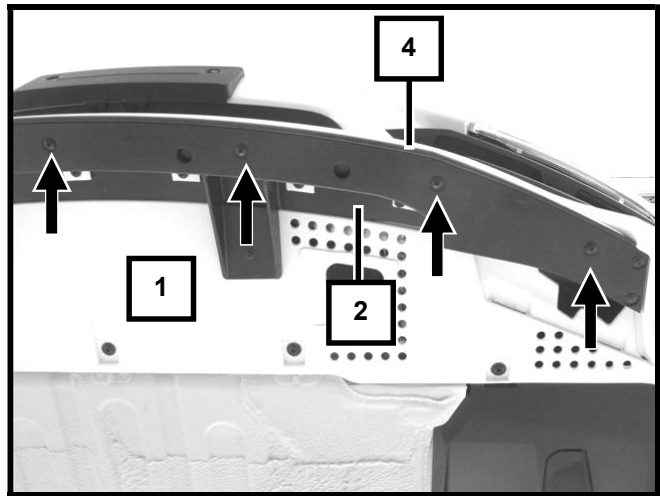

Fig. 10

### 2.3 Preliminary work side skirt

#### Only for Carrera 4 / 4S

- 1 Dismantle the original side skirt. For that turn the clip 90° from the bottom and remove.
- 2 Unclip the original side skirt and remove towards the bottom.

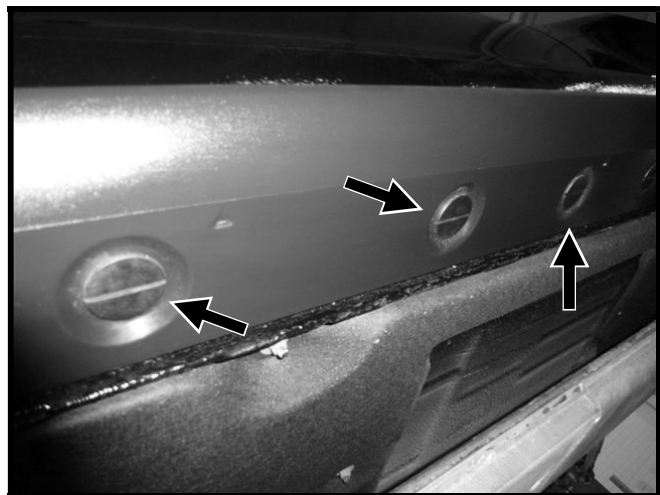

Fig. 11

 The original side skirts are no longer needed.





# ASSEMBLY INSTRUCTIONS

## TECHART Aero-Kit for 991 Carrera

### 2.4 Install TECHART side skirts

**i** The bonding surfaces on the TECHART side skirt and original side skirt must be dry and free from dust and paint spray mist.

Use cleaning agent to thoroughly degrease bonding surfaces on the TECHART side skirt and original side skirt. Then sand it down using 100-180 grade abrasive paper and finally use cleaning agent to degrease it again.

Do not touch the surfaces after they have been cleaned.

- 1 Attach the speed nuts onto the TECHART underbody 091.100.3\_0.20\_ (5).

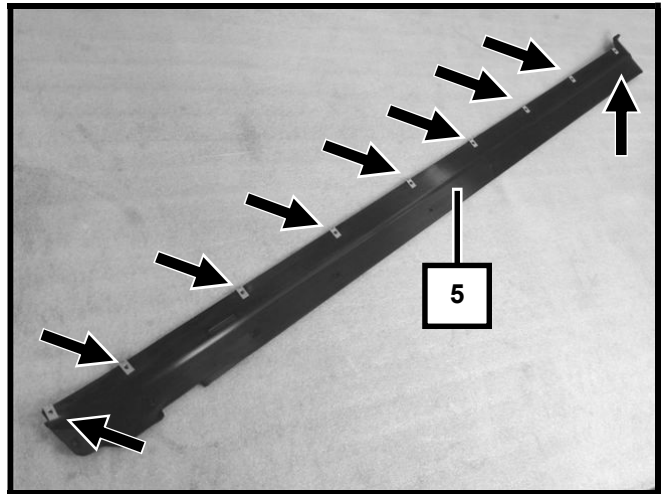

Fig. 12

- 2 Bolt the TECHART side skirt 091.100.3\_0.10\_ (6) with the screws 4.8x16 to the TECHART underbody (5).

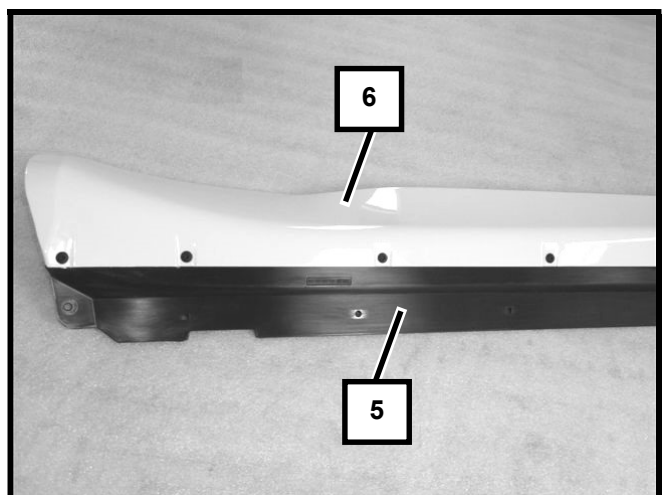

Fig. 13



- 3 Bolt the clip nut 000.100.340.500 (7) to the TECHART underbody (5).

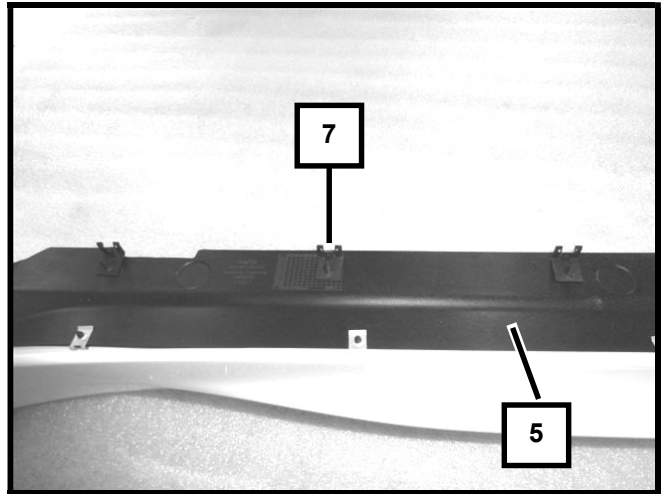

Fig. 14

- 4 Evenly apply the PU-adhesive to the bonding surfaces (b) of the TECHART side skirt (6).

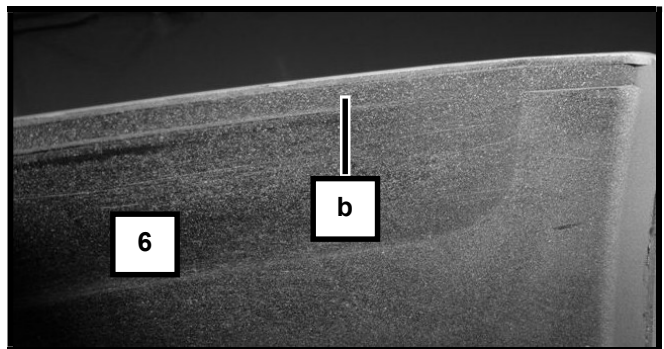

Fig. 15

- 5 Slide the TECHART side skirt with the TECHART underbody on to the original side skirt.
- 6 Align the TECHART side skirt and remove the protective foil.
- 7 Snap the TECHART underbody with the clip nuts to the underbody.
- 8 Affix the stone protective foil in the area of the wheel arch.

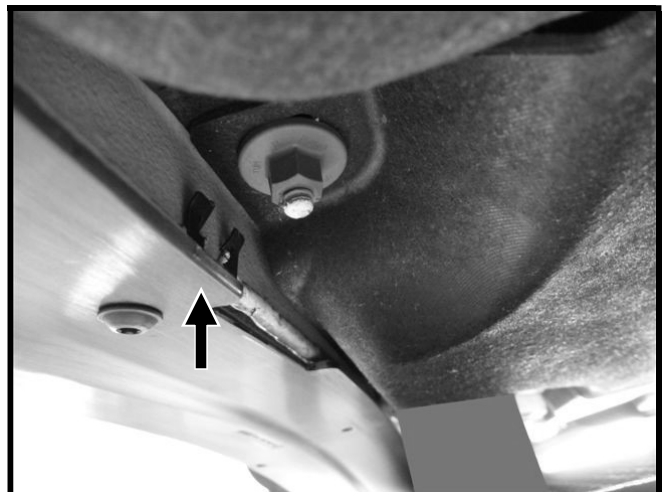

Fig. 16



**Press on firmly in areas coated with adhesive. Check for an accurate fit – Immediately remove any PU adhesive that escapes using a cleaning agent.**

### 2.5 Install TECHART rear spoiler I

**i** The bonding surfaces on the TECHART rear spoiler and original rear spoiler must be dry and free from dust and paint spray mist.

Use cleaning agent to thoroughly degrease bonding surfaces on the TECHART rear spoiler and original rear spoiler. Then sand it down using 100-180 grade abrasive paper and finally use cleaning agent to degrease it again.

Do not touch the surfaces after they have been cleaned.

- 1 Open service lid (for convertibles: set the convertible-top compartment into service position) and dismantle.
- 2 Detach the original rear spoiler (7) from the carrier.

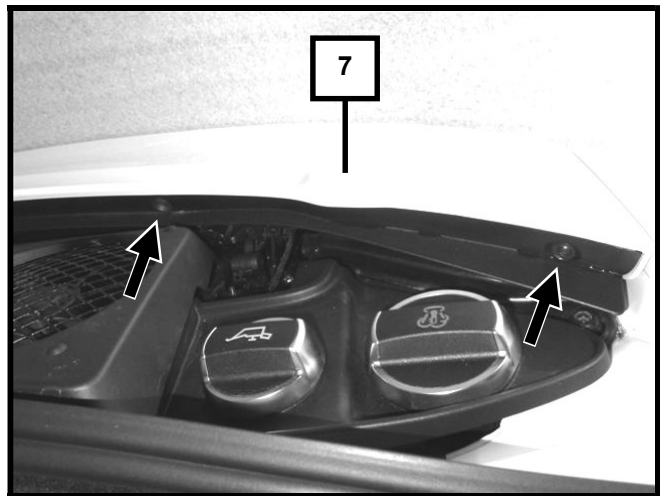

Fig. 17

- 3 Cut out the TECHART drilling template 091.100.800.500-02 (7a).
- 4 Insert the TECHART drilling template (7a) into the original rear spoiler (7), apply at the outside and push towards the front to the stop.
- 5 Mark the holes and pre-drill with the drill  $\varnothing = 3\text{mm}$  and then bore with  $\varnothing = 6\text{mm}$ .



Abb. 18

- 6 Evenly apply the PU-adhesive on the bonding surface.
- 7 Optionally attach the base extensions 091.100.800.20\_ onto the base of the rear spoiler.
- 8 Apply the TECHART rear spoiler I 091.100.800.100 (7b) and align.

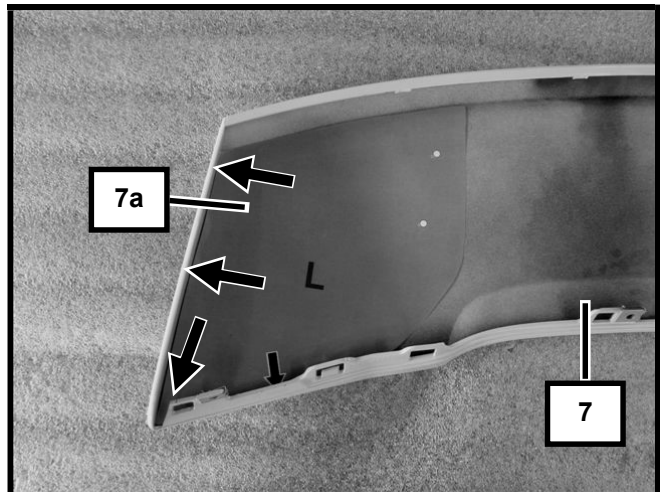
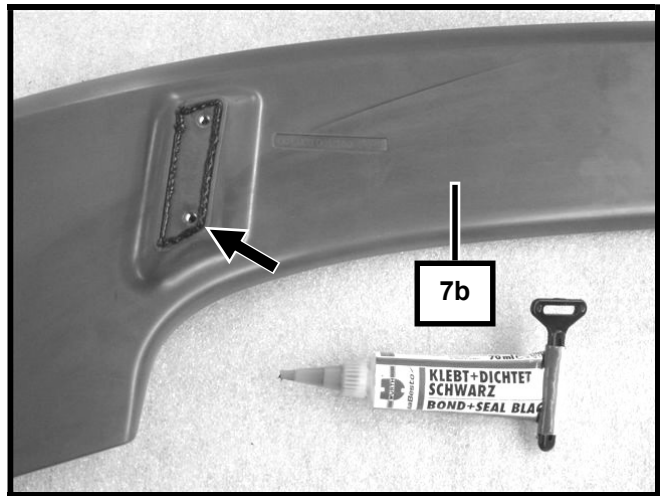

Fig. 19

**i** Press on firmly in areas coated with adhesive. Check for an accurate fit – Immediately remove any PU adhesive that escapes using a cleaning agent.

**i** Allow to dry for at least 12 hours.

- 9 Tighten the TECHART rear spoiler I (7b) with the screw M5x12 or with the TECHART base extension M5x40 and washer 5x15 to the original rear spoiler (7).

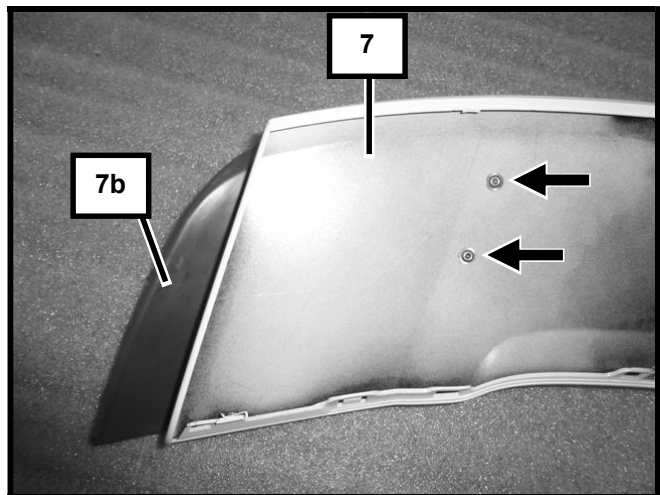

Fig. 20

**i** The screw is only used for the fixation.  
The screw is not meant to be used for fastening.

- 10 Slide the original rear spoiler (7) with the TECHART rear spoiler onto the carrier and tighten.

### 2.6 Install TECHART rear spoiler II

**i** After crimping, heat up all crimp connectors using a hot air gun so that they form a watertight seal.

- 1 Open service lid (for convertibles: set the convertible-top compartment into service position) and dismantle.
- 2 Detach the original rear spoiler (7) from the carrier.

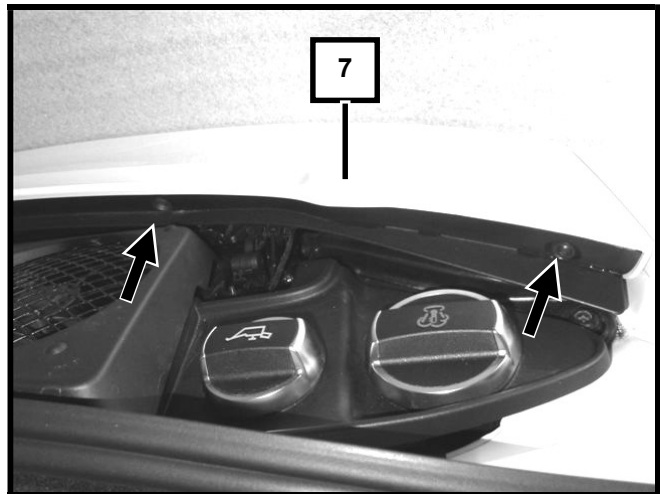

Fig. 21

- 3 Dismantle the center stop light incl. clip from the rear spoiler carrier.
- 4 Detach the original rear spoiler carrier (10).

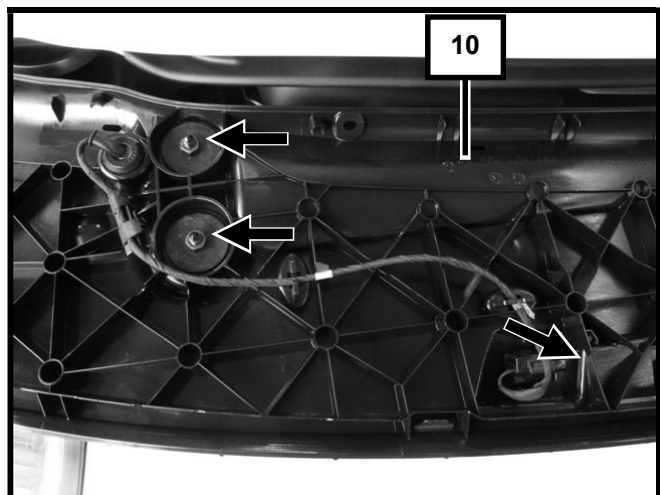

Fig. 22



- 5 Fasten the TECHART rear bracket 091.100.810.300 (11) with both center screws of the rear apron.

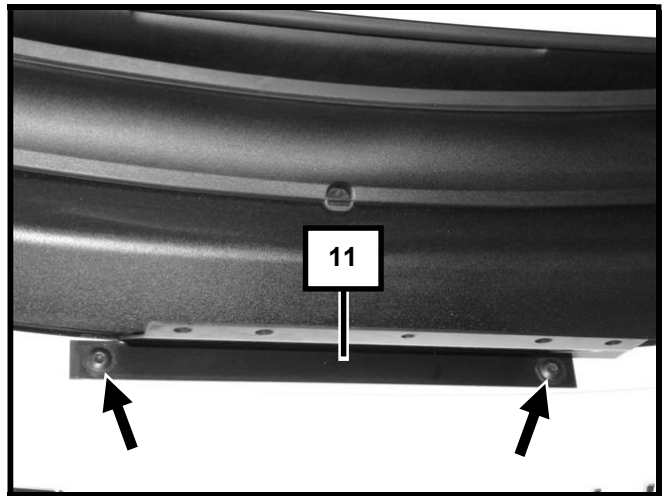

Fig. 23

- 6 Dismantle cover right and left.

**i** Covers are no longer needed.

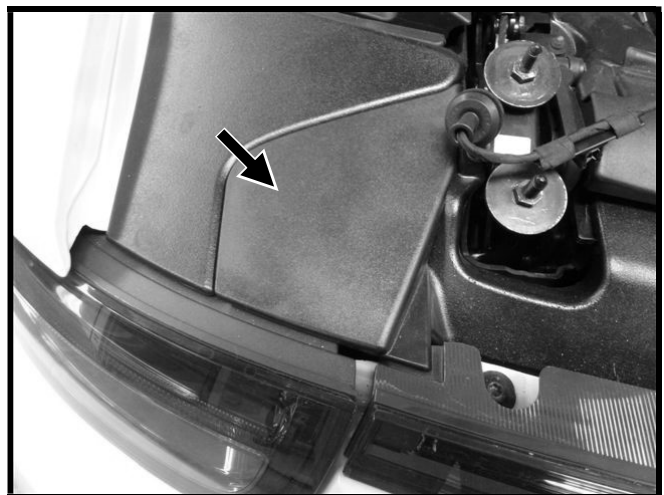

Fig. 24

- 7 Dismantle rear lamp.

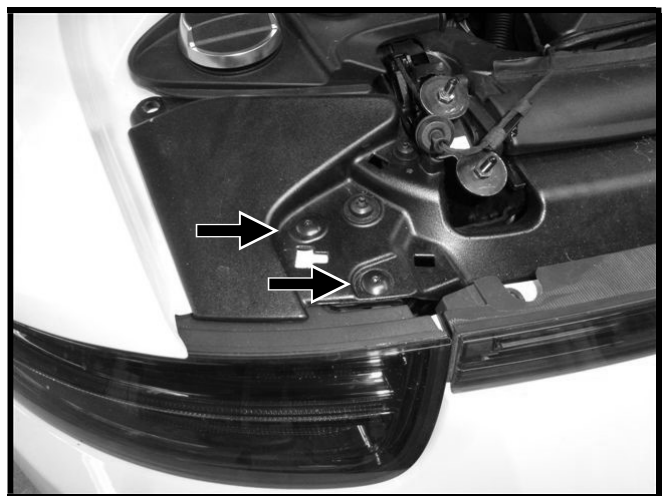

Fig. 25



# ASSEMBLY INSTRUCTIONS

## TECHART Aero-Kit for 991 Carrera

- 8 Insert the TECHART bracket 091.100.810.400/401 (11a) into the dent.

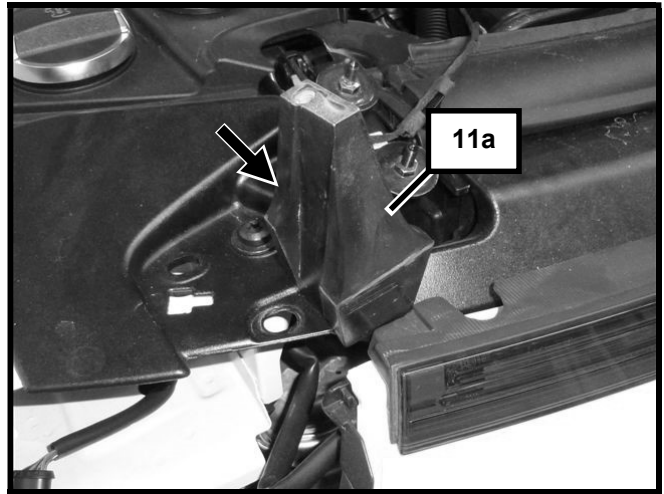

Fig. 26

- 9 Tighten the TECHART bracket (11a) with the screws M5x10 and washer 5x15 to the rear plate.

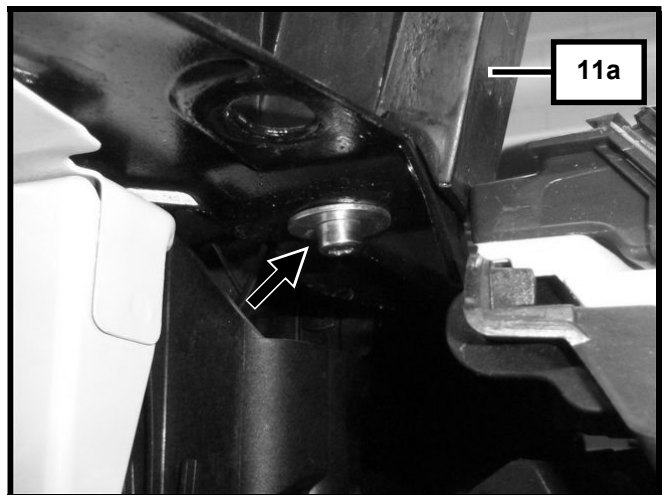

Fig. 27

- 10 Bolt the TECHART brackets for the center stop light 091.100.810.301 (12) with the screws 5x16 to the TECHART base frame hood 091.100.810.101-01 (13).

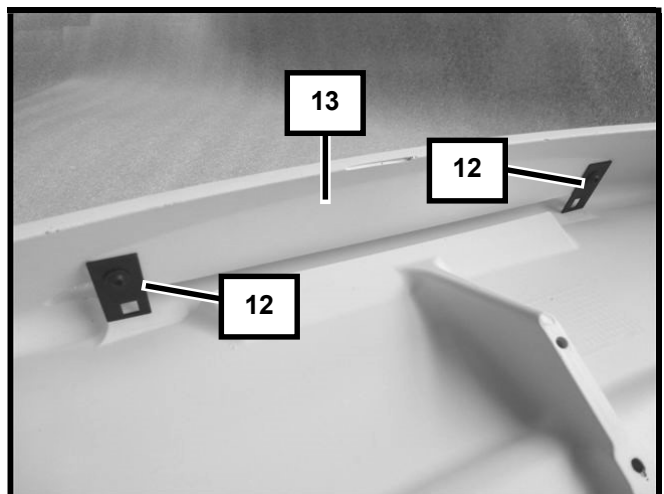

Fig. 28





# ASSEMBLY INSTRUCTIONS

## TECHART Aero-Kit for 991 Carrera

- 11 Tighten the TECHART bracket front top 091.100.810.311 (14a) with the serrated washer M5 to the TECHART base frame (15).
- 12 Tighten the TECHART bracket front top (14a) with the screws M5x10 and the serrated washer M5 to the TECHART bracket front bottom (14b).

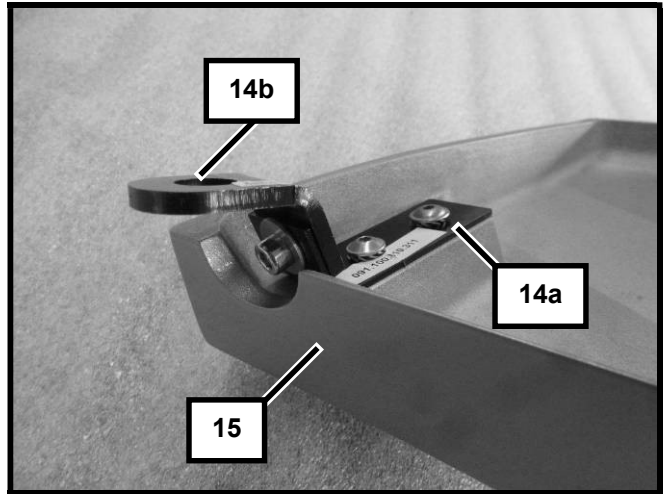

Fig. 29

- 13 Bolt the TECHART base frame hood (13) with the screws M5x16 and the serrated washer M5 to the TECHART base frame (15).

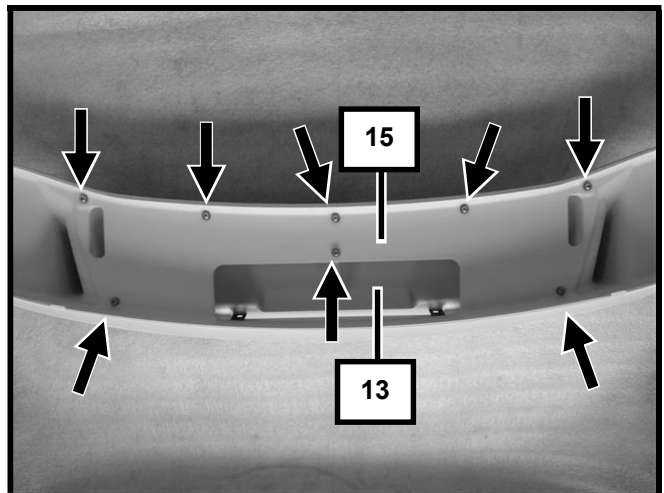

Fig. 30

### For vehicles with catch-rope.

- 14 Thread the TECHART catch-rope 1500mm 000.100.880.150 (22) through the front hole without thread of the TECHART base frame (15).
- 15 Affix the TECHART catch-rope (22) with adhesive tape to the base frame (22).

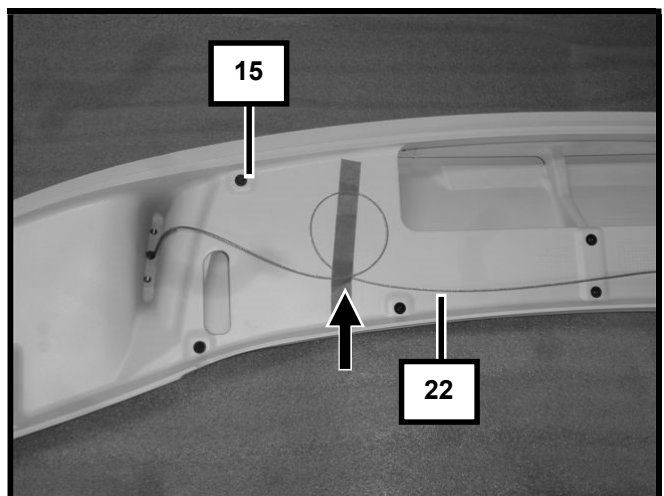

Fig. 31



# ASSEMBLY INSTRUCTIONS

## TECHART Aero-Kit for 991 Carrera

- 16 Unscrew the fastening screws front left and right from the complete rear spoiler drive.
- 17 Route and fit the wiring harness of the center stop light into the TECHART rear spoiler (15).
- 18 Fasten the TECHART front bracket (14) with the original screws to the complete rear spoiler drive.

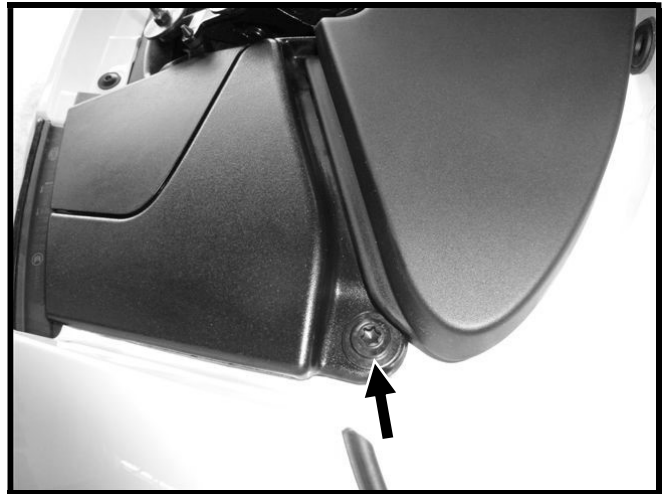

Fig. 32

- 19 Tighten the TECHART base frame (15) with the screws M6x30 to the TECHART bracket (11a).



Abb. 33

- 20 Bolt the TECHART rear bracket (11) with the screws 5x10 to the TECHART rear spoiler hood (13).

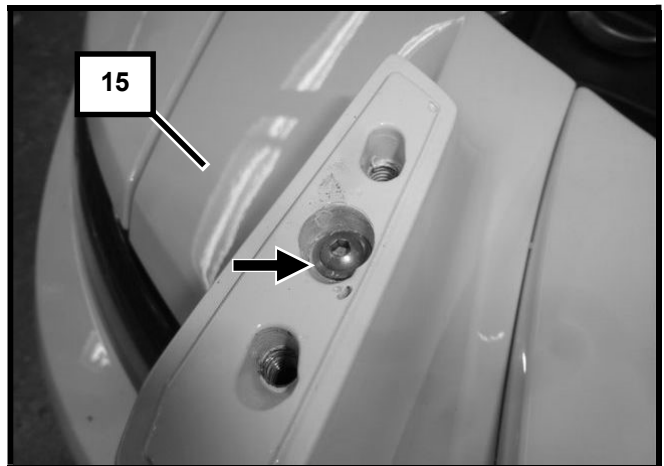
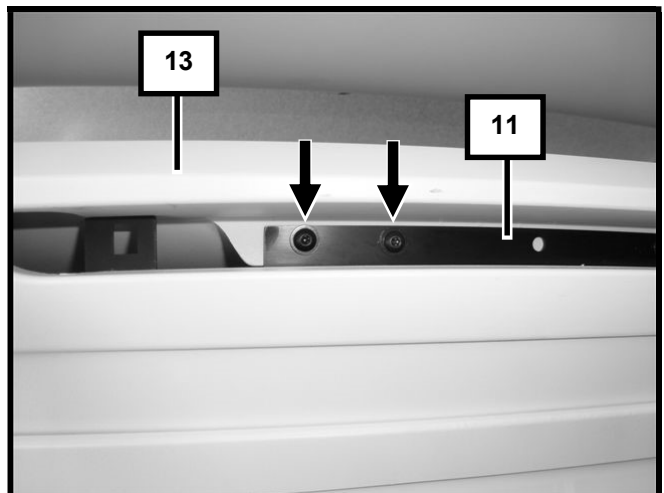

Fig. 34

**i** Attach and align all screws first, then tighten.  
Care for an accurate fit.

- i** Optionally short or long bases can be installed.  
**For convertibles only short bases are possible!**

### Short bases:

- 21 Set the TECHART short base 091.100.810.210/211 (17) onto the TECHART base frame (15) and tighten with the screws M8x90 (18) into the TECHART base frame (15).

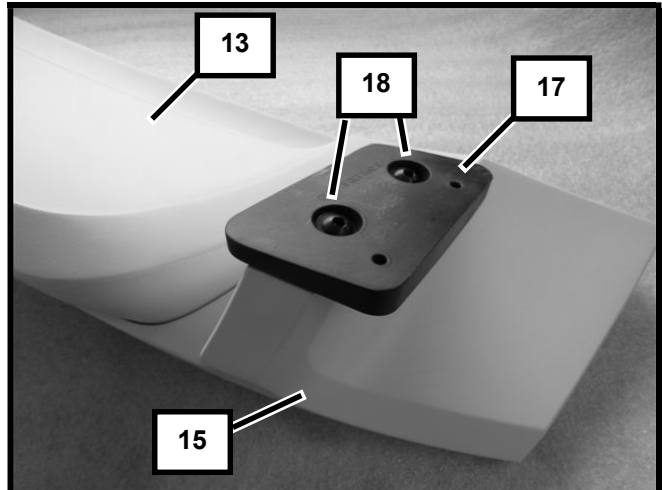

Fig. 35

### Long bases:

- 22 Set the TECHART long base plate 091.100.810.222/223 (19) and base 091.100.810.220/221 (20) onto the TECHART base frame (15) and tighten with the screws M8x90 (18) into the TECHART base frame (15).

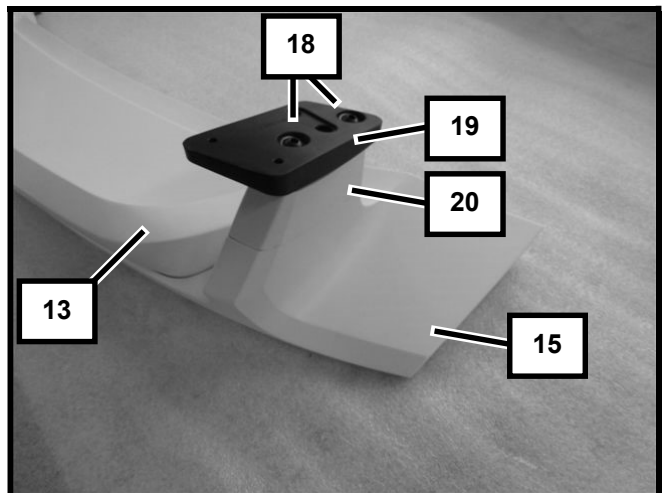

Fig. 36

### Convertible long bases w/o TÜV

- 23 Set the TECHART base convertible 091.100.881.210/211 (21) onto the TECHART base frame (24) and tighten with the screws M8x90 (18).

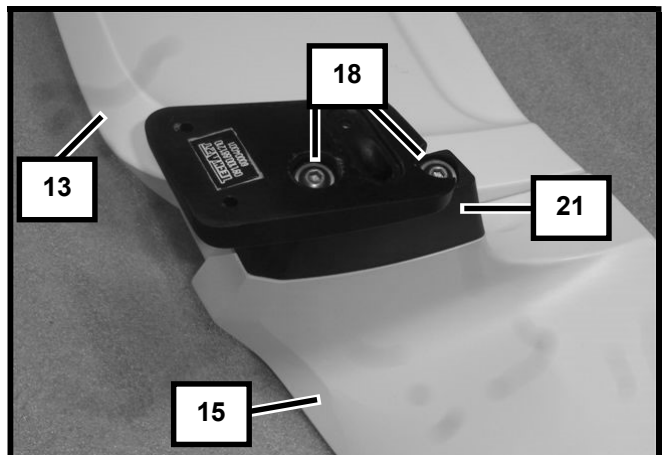

Fig. 37

### Coupe with catch-rope

- 24 Thread the TECHART catch-rope 1500mm (30) through the TECHART base long (20a).

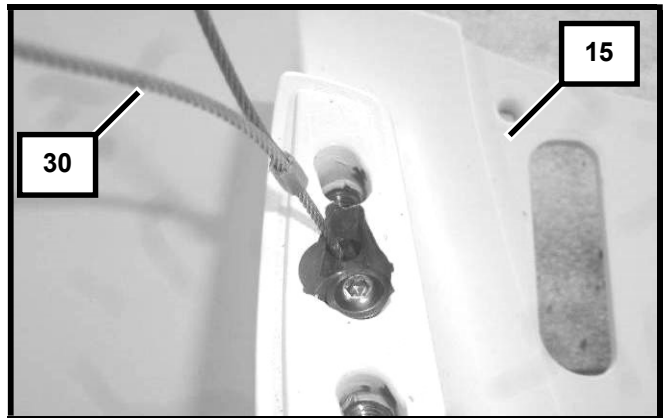

Fig. 38

- 25 Set the TECHART base long, Switzerland 091.100.810.220S/221S (20a) onto the TECHART base frame (15) and tighten with the hexagon socket head screws M8 x 80 (18).

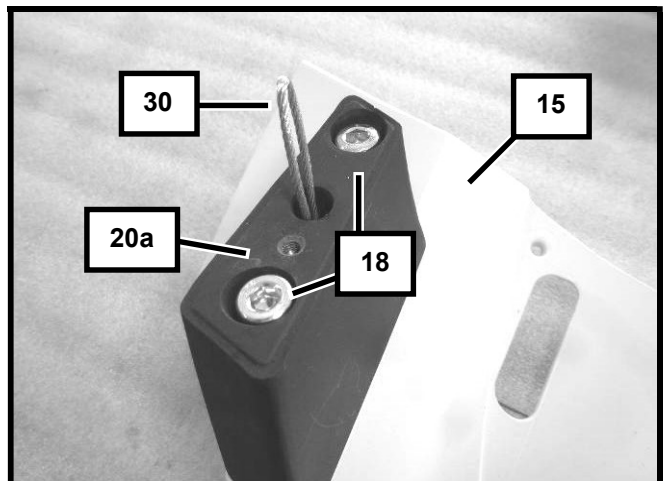

Fig. 39

- 26 Thread the TECHART catch-rope 1500mm (30) through the TECHART base plate long, Switzerland 091.100.810.222S/223S (19a).

- 27 Set the TECHART base plate long Switzerland (19a) onto the TECHART base long Switzerland (20a) and tighten with the plastic screws DIN 912 M5x20 (23).

- 28 Tighten the TECHART catch rope (30) with the screw M5x16 to the TECHART wing profile. See arrow.

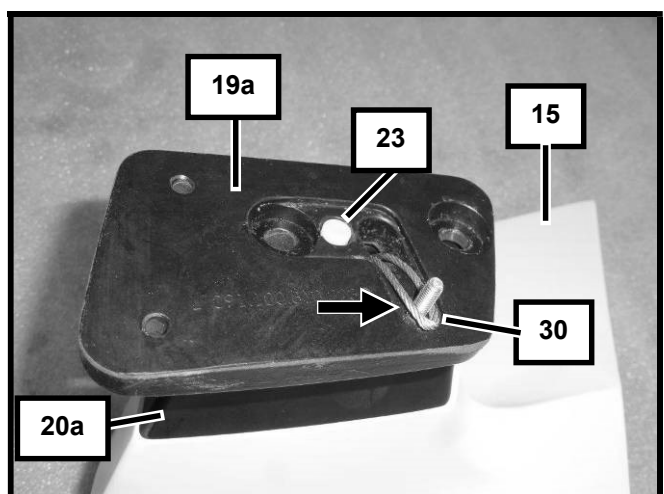

Fig. 40

**i** Please not the tightening torque for the plastic screw DIN 912 M5x20 = 0.6Nm.  
Failure to comply can cause the damage of the screw.



# ASSEMBLY INSTRUCTIONS

## TECHART Aero-Kit for 991 Carrera

### Short bases:

- 29 Bolt the TECHART wing profile 091.100.810.200 (21) with the screws M5x16 to the TECHART short base (17).

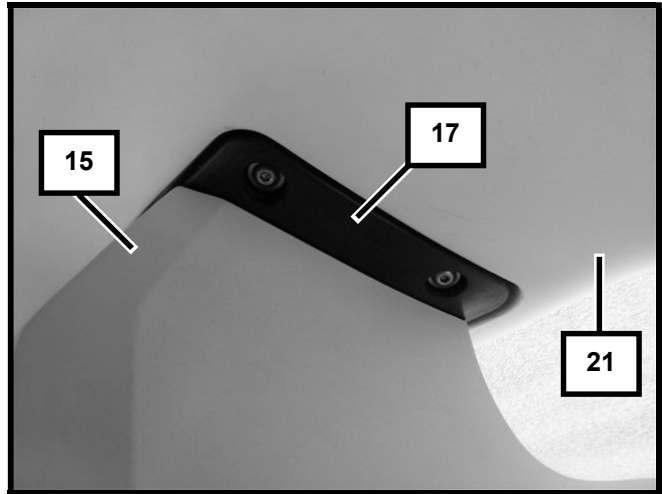

Fig. 41

### Long bases:

- 30 Bolt the TECHART wing profile 091.100.810.200 (21) with the screws M5x16 to the TECHART long base (19).

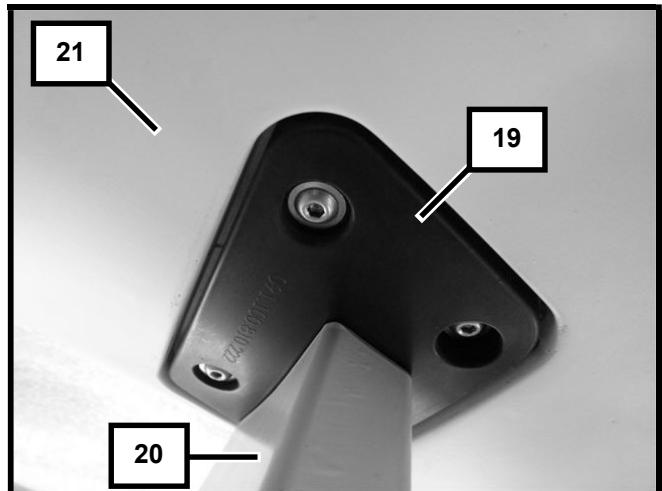

Fig. 42

- 31 Clip the fixing clip 99950758401 of the center stop light into the TECHART stop light bracket (12).
- 32 Slide the sleeve 95555958600 onto the bracket of the center stop light.
- 33 Connect the center stop light electronically and clip into the TECHART base frame hood.
- 34 Unscrew and unclip the three louvers incl. the center high-mounted stop light from the inside.
- 35 Unclip the center high-mounted stop light from the louvers.



### Coupe:

- 36 Route the wiring harness of the center high-mounted stop light to the plug of the rear spoiler (right maintenance area). For that turn the rubber grommet in the panel sheet, see arrow.

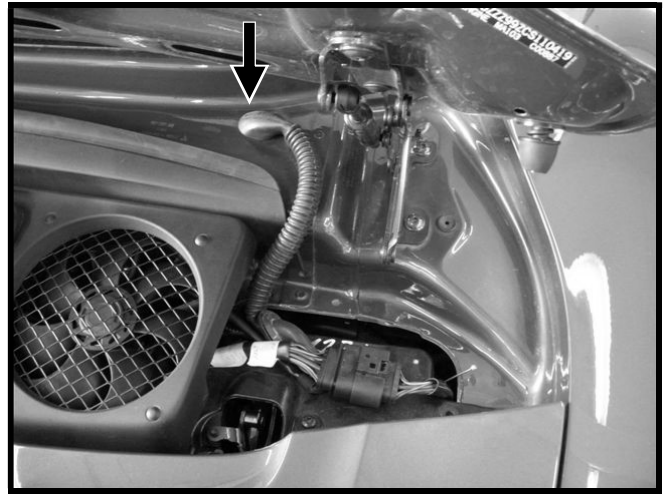

Fig. 43

### Convertible:

- 37 Dismantle the wiring harness of the center high-mounted stop light from the convertible-top compartment and route to the plug of the rear spoiler (right maintenance area).



Fig. 44

- 38 Separate the cable black/red Pin 4 about 20 mm in front of the 14-fold plug.
- 39 The ending towards the vehicle stays free. Insulate well.
- 40 Connect the cable black/red of the wiring harness from the center high-mounted stop light and the black/red cable from the plug with the red crimp connector.



- 41 Clip in the louvers again.
- 42 Stick the decal for the center stop light 091.100.810.500 (21) to the center high-mounted stop light.
- 43 Clip in the TECHART center high-mounted stop light, without the electrical connection.

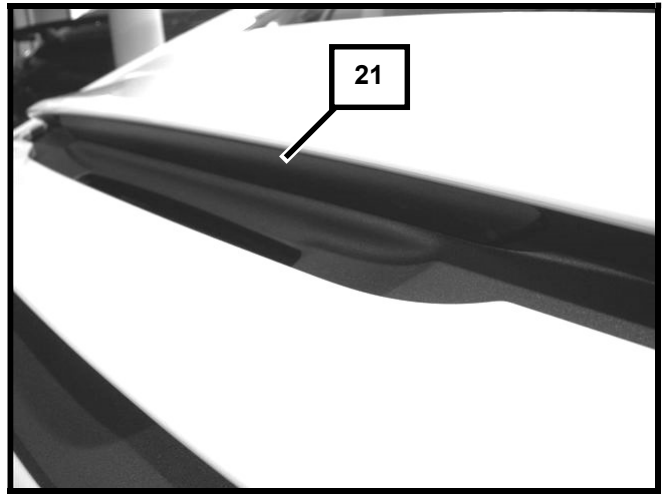

Fig. 45

- 44 Recode the vehicle with the PIWIS to fixed rear spoiler.
  - Additional menu
  - Vehicle data maintenance / scroll to:
  - Coding Aerokit cup / on / scroll to:
  - Safe
  - Return
  - Coding rear control unit
  - Automatic coding



**For vehicles with sunroof:**

**With an open roof and a speed over 160km/h the multifunctional display shows the information: “close roof”.**

### 3 Final check

- 1 Perform a general function check on vehicle. Check the illumination.



# ASSEMBLY INSTRUCTIONS

**TECHART Aero-Kit for 991 Carrera**



**TECHART AUTOMOBILDESIGN GMBH**

RÖNTGENSTRASSE 47  
71229 LEONBERG / GERMANY

TEL +49 7152 / 9339- 0

FAX +49 7152 / 9339-33

[info@techart.de](mailto:info@techart.de)

[www.techart.de](http://www.techart.de)

*Subject to change at any time without prior notice.*  
Copyright 2021 by **TECHART** Automobildesign GmbH

Part No. 091.100.100.099